

LUND INSTITUTE OF TECHNOLOGY  
LUND UNIVERSITY

---

Division of Building Materials

**NEW CONCRETE MATERIALS  
TECHNOLOGY FOR COMPETITIVE  
HOUSE BUILDING**

Markus Peterson



Report TVBM-3111

Lund 2003

---

## **Abstract**

Cast in-situ concrete is the most frequently used material internationally for the construction of structural frames in low- medium rise house building. In Sweden, however, this technology is criticised for short slab spans (limited flexibility for future refurbishment), long production times, unhealthy work environment, indoor air problems etc. Many of these disadvantages are due to the fact that by tradition ordinary low-grade concrete is used in house building. Extensive concrete materials research on high performance concrete (HPC) and self-compacting concrete (SCC) has revealed opportunities to counter the criticism, but the technologies are not yet utilised in house building to large extent. The research project aims at investigating the potential of HPC and SCC for competitive design, production and function of structural frames of cast in-situ concrete in house building. The method of the project include several parameter studies where HPC is compared to ordinary concrete as well as an interview study focusing on building process issues. The main conclusions are that use of HPC can increase the slab span significantly (by utilisation of increased tensile strength and E-modulus), reduce the production time strongly (by rapid drying and strength development) and also increase the building function (increased flexibility, acoustic and indoor air quality). Concerning SCC there is a large potential for improved work environment and productivity. There are also technical as well as building process related obstacles for the implementation of HPC and SCC, which are analysed and described together with proposed solutions.

## Preface

The work for this thesis has been carried out at the Department of Building Materials at Lund University, in collaboration with Skanska Sweden – Asphalt and Concrete. The project has formed a part of the Swedish research programme Competitive Building. The project has been financially supported by Skanska Sweden – Asphalt and Concrete, The Swedish Foundation for Strategic Research “SSF” and Svenska Byggbranschens Utvecklingsfond “SBUF”, who all are gratefully acknowledged.

I am grateful to my supervisor, Professor Göran Fagerlund, for his inspiration and valuable discussions throughout the work. I would also like to express my gratitude to Professor Kyösti Tuutti at Skanska and University of Lund and Per-Ola Jönsson at Skanska Asphalt and Concrete for initiating the project.

I would also like to thank all colleagues and friends at Skanska, the Department of Building Materials at Lund University and within Competitive Building for interesting discussions and valuable support.

# List of contents

|  |           |
|--|-----------|
| Abstract   | i         |
| Preface  | ii        |
| <b>Introduction</b>  | <b>1</b>  |
| Background   | 1         |
| Aim  | 1         |
| Methods  | 1         |
| Outline of thesis  | 2         |
| Summary  | 5         |
| <b>1. Concrete materials technology and the building process concerning house building today</b> | <b>7</b>  |
| <b>1.1 Technical aspects</b>   | <b>7</b>  |
| 1.1.1 Structural frames in house building – generally  | 7         |
| 1.1.2 Structural frames of cast in-situ concrete   | 7         |
| <b>1.2 Building process related issues – based on an interview study</b>                         | <b>9</b>  |
| 1.2.1 Introduction   | 9         |
| 1.2.2 Influence of the form of contract on the choice of structural frame                        | 10        |
| 1.2.3 Influence of actors on the choice of structural frame materials                            | 11        |
| 1.2.3.1 The architect  | 11        |
| 1.2.3.2 The structural engineer  | 12        |
| 1.2.3.3 The contractor   | 12        |
| 1.2.3.4 The concrete supplier  | 13        |
| 1.2.4 Building process related aspects on structural frames – summary and conclusions            | 15        |
| <b>2. New concrete materials technology (HPC and SCC)</b>  | <b>16</b> |
| <b>2.1 HPC</b>   | <b>16</b> |
| 2.1.1 HPC – history  | 16        |
| 2.1.1.1 International research and experience  | 16        |
| 2.1.1.2 Swedish research and experience  | 17        |
| 2.1.2 HPC – some important properties compared to NPC  | 18        |
| 2.1.3 HPC – benefits (generally)   | 23        |
| 2.1.3.1 Structural design related potential of HPC   | 23        |
| 2.1.3.2 Production related potential of HPC  | 24        |
| 2.1.3.3 Building function related potential of HPC   | 26        |
| 2.1.4 HPC – obstacles (generally)  | 26        |
| 2.1.4.1 Technical obstacles  | 27        |
| 2.1.4.2 Obstacles with regard to the building process  | 27        |
| <b>2.2 SCC</b>   | <b>27</b> |
| 2.2.1 SCC – history  | 27        |
| 2.2.1.1 International research and experience  | 27        |
| 2.2.1.2 Swedish research and experience  | 28        |
| 2.2.2 SCC – technical properties   | 28        |
| 2.2.3 SCC – benefits (generally)   | 29        |
| 2.2.3.1 General  | 29        |
| 2.2.3.2 Production related potential of SCC  | 30        |
| 2.2.3.3 Design related potential of SCC  | 30        |
| 2.2.4 SCC – obstacles (generally)  | 30        |
| 2.2.4.1 Technical obstacles  | 30        |
| 2.2.4.2 Obstacles with regard to the building process  | 31        |

|  |           |
|--|-----------|
| <b>3. Structural potential of HPC within house building</b>                          | <b>32</b> |
| <b>3.1 Introduction</b>  | <b>32</b> |
| <b>3.2 Slab constructions – general conditions</b>                                   | <b>33</b> |
| 3.2.1 Concrete parameters  | 33        |
| 3.2.2 Loads  | 35        |
| 3.2.3 Deflection   | 35        |
| 3.2.4 Reinforcement  | 35        |
| 3.2.5 Studied plate types – general properties                                       | 36        |
| <b>3.3 Structural calculations</b>   | <b>39</b> |
| 3.3.1 Calculations performed   | 39        |
| 3.3.2 Method of calculation – norms and equations (Swedish Building Code BBK94)      | 40        |
| 3.3.3 Material data  | 41        |
| <b>3.4 Result</b>  | <b>41</b> |
| 3.4.1 Comparison between NPC and HPC regarding maximum slab span                     | 41        |
| 3.4.2 Effects of concrete properties on maximum slab span for slab/wall structures   | 43        |
| 3.4.3 Effects of concrete properties on maximum slab span for slab/column structures | 44        |
| 3.4.4 Summary  | 45        |
| <b>3.5 Additional discussion of result</b>   | <b>46</b> |
| 3.5.1 Ultimate limit state   | 46        |
| 3.5.2 Serviceability limit state   | 49        |
| 3.5.3 Additional results   | 50        |
| 3.5.4 Concluding remarks   | 52        |
| <br>   |           |
| <b>4. Production related potential for new concrete materials technology</b>         | <b>55</b> |
| <b>4.1 Utilisation of HPC for increased productivity</b>                             | <b>55</b> |
| 4.1.1 Utilisation of HPC for reduced drying time                                     | 55        |
| 4.1.1.1 Introduction   | 55        |
| 4.1.1.2 Calculation for Climate 1  | 57        |
| 4.1.1.3 Calculation for Climate 2  | 61        |
| 4.1.1.4 Calculation for Climate 3  | 63        |
| 4.1.1.5 Calculation for Climate 4  | 64        |
| 4.1.1.6 Calculation for Climate 5  | 66        |
| 4.1.1.7 Effect of concrete temperature   | 68        |
| 4.1.1.8 Effect of outer climate conditions   | 70        |
| 4.1.1.9 Analysis   | 71        |
| 4.1.1.10 Discussion  | 71        |
| 4.1.1.11 Conclusions   | 72        |
| 4.1.1.12 Utilisation of result for rationalised production                           | 73        |
| 4.1.2 Utilisation of HPC for rapid strength development                              | 74        |
| 4.1.2.1 Introduction   | 74        |
| 4.1.2.2 Early stripping of formwork  | 75        |
| 4.1.2.3 Freezing of concrete   | 80        |
| 4.1.2.4 Early post-tensioning  | 83        |
| 4.1.2.5 Summary of result and conclusions  | 84        |
| <b>4.2 Utilisation of SCC for more rational production</b>                           | <b>86</b> |
| 4.2.1 Work-environmental aspects   | 86        |
| 4.2.1.1 Elimination of the “white fingers syndrome”                                  | 86        |
| 4.2.1.2 Reduction of heavy work  | 86        |
| 4.2.1.3 Noise decrease   | 86        |
| <b>4.2.2 Utilisation of SCC for more rational production methods</b>                 | <b>87</b> |
| 4.2.2.1 Reduction Personnel  | 87        |
| 4.2.2.2 Reduction of finishing work  | 87        |
| 4.2.2.3 Increased productivity   | 87        |
| 4.2.2.4 Casting of advanced structures   | 87        |
| 4.2.2.5 Economical aspects   | 88        |

|  |            |
|--|------------|
| <b>5. Building function related potential of new concrete materials technology</b> | <b>89</b>  |
| 5.1 Increased flexibility/future refurbishment by utilisation of HPC               | 89         |
| 5.2 Reduced moisture problems by utilisation of HPC                                | 90         |
| 5.3 Increased acoustic quality by utilisation of HPC                               | 90         |
| 5.4 Decreased energy-consumption by utilisation of HPC                             | 92         |
| 5.5. Utilisation of synergy effects (no sub optimisation)                          | 86         |
| <b>6. Obstacles for the implementation of new concrete materials technology</b>    | <b>93</b>  |
| <b>6.1 Technical obstacles</b>   | <b>93</b>  |
| <b>6.1.1 Technical obstacles for the implementation of HPC</b>                     | <b>93</b>  |
| 6.1.1.1 Technical obstacles related to the ready-mix concrete production           | 93         |
| 6.1.1.2 Technical obstacles related to fresh concrete on site                      | 94         |
| 6.1.1.3 Technical obstacles related to the function of the hardened concrete       | 95         |
| <b>6.1.2 Technical obstacles for the implementation of SCC</b>                     | <b>95</b>  |
| 6.1.2.1 Technical obstacles due to production difficulties                         | 95         |
| 6.1.2.2 Technical obstacles due to lack of knowledge                               | 96         |
| <b>6.2 Obstacles related to the building process</b>                               | <b>97</b>  |
| 6.2.1 Organisation   | 97         |
| 6.2.2 Economy  | 98         |
| 6.2.3 Building codes   | 98         |
| <b>7. Conclusions</b>  | <b>100</b> |
| <b>References</b>  | <b>104</b> |
| <b>Appendices</b>  |            |
| <b>Appendix A</b> Structural study – background information                        |            |
| <b>Appendix B</b> Structural design study – results                                |            |
| <b>Appendix C</b> Drying of HPC – results  |            |

# Introduction

## Background

There are several concepts for the construction of structural frames in low- medium rise buildings, e.g. cast in-situ concrete, prefabricated concrete elements, steel and wood. Since many decades, cast in-situ concrete has been the dominant structural frame building material both in Sweden and on the international market. In Sweden, however, cast in-situ concrete frames are criticised for short slab spans (limited flexibility for future refurbishment), long production times, unhealthy work environment, indoor air problems etc. Although novel concrete research presents technical solutions to the described problems and the market shares of competing materials are increasing, cast in-situ concrete within house building is still based on almost the same technology as decades ago.

During the 80s and 90s, intense international concrete materials research has resulted in two novel concrete technologies, high performance concrete (HPC) and self-compacting concrete (SCC). These technologies may solve many of the problems cast in-situ concrete structural frames are criticised for. Still today though, HPC is mainly utilised within civil engineering construction and the delivered volumes of SCC are significantly limited.

If HPC and SCC are to be further utilised within the construction of structural cast in-situ concrete frames in low- medium rise buildings, a wide range of aspects probably must be considered, with regard to benefits as well as disadvantages. The studies of the project address the theoretical potential of HPC and SCC for exploiting and improving the performance of cast in-situ concrete structural frames with regard to structural design, production and future function.

## Aim

The research project aims at investigating the potential of new concrete materials technology (HPC and SCC) for competitive construction of cast in-situ concrete structural frames in residential low- medium rise house-buildings. To avoid sub-optimisation, the focus is spread on structural design, production and building function related aspects. Regard is taken to both technical and building process related obstacles.

## Methods

Briefly, the following methods are used within the project. For further descriptions, see the method section for each study.

- **Interviews** (building process related issues)  
Interviews with a wide range of actors and experts within the house-building sector have been carried out with the aim of describing building process related issues concerning the choice of materials for structural frames.
- **Parameter studies** (structural design aspects of HPC)  
To estimate the design related potential of HPC, parameter studies using the PC-program FEM-Design Plate (FEM-Design Plate, 2000) has been conducted.

- **Parameter studies** (production time related issues of HPC)  
To analyse production related aspects of HPC, two PC-tools have been used:
  - TorkaS 1.0, for estimating/simulating influencing parameters on the concrete drying (TorkaS 1.0, 1998)
  - Hett97, for estimating/simulating the effects relevant for the concrete strength development (Hett97, 1997)
- **Field studies** (production oriented issues concerning SCC)  
To some extent, field studies have been carried out for describing varying experiences of SCC on site.
- **Desktop studies**  
To analyse the parameter studies, desktop studies using MS Excel have been performed. Literature studies have been conducted for describing technical properties, international research and implementation experiences of HPC and SCC.

## **Outline of the thesis**

### **Chapter 1 Concrete materials technology and the building process concerning house building today**

The concrete materials used in structural frames in Sweden today are described. Special focus is set on disadvantages of average house-building concrete compared to competing materials techniques. Also the house-building process of today is described, where special attention is paid to the actors' influence on decision-making regarding the chosen type of materials in structural frames. The latter study is based on interviews of actors within the building sector.

### **Chapter 2 New concrete materials technology (HPC and SCC)**

Novel concrete materials technology is described, focusing on properties, international research and experiences of implementation. Also the potential of HPC and SCC for competitive construction of concrete structural frames in low- medium rise house-buildings is *briefly* described, as well as the technical and building process related obstacles for implementation.

### **Chapter 3 Structural potential of HPC within house building**

Parameter studies are conducted in order to investigate the structural design related potential of HPC for concrete structural frames within low- medium rise house buildings. The studies are based on calculations, by using the PC- tool "FEM-design Plate" (FEM-Design Plate, 2000), where the influence of concrete parameters (compressive and tensile strength, elastic modulus, concrete slab thickness etc), amount of reinforcement and type of structure (various slab/wall and slab/column structures) are simulated. The study primarily aims at investigating the opportunity for increasing concrete slab spans through utilisation of HPC and secondary at exploring the potential for further rational utilisation of reinforcement.



## **Chapter 4 Production related potential of new concrete materials technology**

To analyse the production related potential of HPC, parameter studies both concerning concrete drying times and strength development are carried out. In the first study, the effects of concrete properties (water/cement ratio, cement content, silica fume content etc) and surrounding conditions (drying climate conditions, type of formwork, slab thickness etc) on the required time for reaching specific RH levels are estimated. Used tool is the PC-program “TorkaS 1.0” (TorkaS, 1998), which simulates the drying process of concrete for various conditions.

The latter study has aimed at estimating the strength development which affects, for instance, the formwork removal times and technical problems connected to casting wintertime. The PC-tool “Hett97” has been utilised for estimating the effects of concrete properties (concrete quality, cement content etc) and surrounding conditions (outer air temperature, type of formwork etc) on the required time for reaching specific strength levels (Hett97, 1997). Special attention has been paid to how various winter casting methods (covering, insulating and heating of concrete) affect the strength development.

The two studies have also been combined for simulating the effects on the drying time of cold climate conditions during the casting.

The production related potential of SCC is exemplified by various benefits, both regarding improved work environment and increased rationality of the production. The study is limited to describing rather than investigating the potential of SCC.

## **Chapter 5 Building function related potential of new concrete materials technology**

Synergy effects of using HPC on the function of the building are described, e.g. increased flexibility regarding future refurbishment, reduced moisture problems, increased acoustic quality and reduced energy consumption. The two latter effects can be seen as advantages for concrete structural frames in general, but HPC generates further opportunities for trouble-free building due to the short drying time that for NPC affects thick concrete structures in a negative way by extended drying/production times.

## **Chapter 6 Obstacles for the implementation of new concrete materials technology**

The obstacles for implementation and utilisation of HPC and SCC are discussed and divided into technical and building process related issues. The technical barriers consider difficulties in mix-proportioning, practical problems of the fresh concrete on site, as well as problems of the result with regard to the hardened concrete. Also uncertain factors requiring more research are described. The building process oriented impediments discussed, are the general organisational barriers for inventions, as well as more specific obstacles, e.g. responsibility questions and lowered need for manpower. The influence of the limitations in building regulations is further discussed.

## **Chapter 7 Conclusions**

Finally, the main results of the study are discussed. Special attention is paid to the importance of the synergy effects, necessary further for realisation of the wide potential of HPC and SCC and for competitive construction of structural frames. Also the limitations of the research project and the need for further research are discussed.

## **Appendices**

**Appendix A** Structural design study – background information

**Appendix B** Structural design study – results

**Appendix C** Drying of HPC - results

## Summary

Decision criteria for the choice of building materials for structural frames are dependent on the actors involved, which further depend on the form of contract. Cast in-situ concrete is by tradition the most used structural frame concept but is challenged by competing techniques. Generally, the usage of cast in-situ concrete in house building is based on average low-grade house-building concrete and further criticised both from technical and building process points of view. However, novel and intense concrete research has led to new concrete materials technologies, as for instance high performance concrete (HPC) and self-compacting concrete (SCC). These technologies may solve many of the criticised issues, e.g. long production times, short slab spans, unhealthy work environment and indoor air problems, but today these technologies are seldom utilised within the production of low- medium rise house buildings, compared to civil engineering constructions or prestigious high-rise buildings.

The project aims at estimating the potential for improved and cost-efficient structural design, production and function of residential low- medium rise buildings through utilisation of HPC and SCC. To estimate the theoretical potential, both technical and building process related issues are studied, and further the benefits as well as the obstacles for implementation are discussed.

### *Structural design issues*

The design study is based on parameter studies where effects on the structural design performance of various concrete properties for normal performance concrete (NPC) are compared to HPC. The result presents a significant potential of HPC for increasing the slab spans or reducing the dimensions if increased tensile strength and/or elastic modulus are utilised. The design study also describes a more competitive method of utilising the reinforcement when required reinforcement is based on the varying moment instead of the maximum moment of the slab.

### *Production issues*

HPC for increased structural design performance also leads to the opportunities for shortening the production time and further reducing the production costs if synergy effects, as like the fast strength development and the reduced drying time are utilised. The HPC production study, which is based on parameter studies, results in analyses of influencing parameters on the concrete drying as well as the strength development. The influences of concrete properties, formwork systems, surrounding climate conditions etc are quantified. Also the production oriented potential of SCC is described, e.g. improved work environment, increased productivity and opportunities for producing advanced designed structures.

### *Building function issues*

The third aspect of HPC:s potential lies in its' effects on the finished building function. Benefits, such as increased flexibility for future refurbishment (through increased slab spans), improved indoor air quality (reduced moisture based problems), higher acoustic quality (by utilising the opportunities for producing thicker constructions without extended production times) and future energy savings (due to the high level of heat capacity of concrete) are described. Some of these are not only connected to HPC though, but to concrete structural frames in common.

### *Obstacles for the implementation*

Technical as well as building process related obstacles for the implementation of new concrete materials technologies within house building are discussed. The main technical impediments of HPC are the difficulties in managing the high quality requirements regarding the mix ingredients, workability issues and performance problems of the hardened concrete. When it comes to SCC, the main technical is the risk for non-robust concrete due to improper mix design, which may be based on insufficient technical knowledge regarding the mix ingredients' influence on the self-compacting mechanism.

Non-technical barriers for the exploitation of new technologies within the building sector are commonly based on economical issues. The direct materials costs may seemingly exceed the cost-savings if not the *total* potential is taken into regard. Other building process related impediments are related to traditions concerning the choice of materials, improper cooperation between the actors, lack of information, insufficient feedback, limiting norms, unclear responsibility, lack of technical knowledge of the new materials etc.

### *Total theoretical potential*

The study ends with a summarising discussion of the total theoretical potential of HPC and SCC for improving the structural design, production and function of structural frames in house buildings. Special attention is paid to the importance of the project planning phase and exploitation of the synergy effects instead of optimising a few aspects, if a cost efficient solution is going to be managed, also from a long time perspective.

# Chapter 1

## Concrete materials technology and the building process concerning house building today

### 1.1 Technical aspects

#### 1.1.1 Structural frames in house building – generally

Various concepts of structural frames are used in residential buildings. Within the production of single-family houses and low-rise buildings in Sweden, prefabricated wooden frames are the most frequently used material. Regarding multi-dwelling houses in the form of low-medium rise buildings though, concrete is the most used material, either as cast in-situ (fresh concrete transported to and cast on the building site) or as prefabricated elements. Other structural frame concepts on the market are concrete-steel composites and timber. According to a survey of market shares of materials in structural frames produced in 1998 in Sweden, by Mångda (1999), cast in-situ concrete is used to 65%, prefabricated elements to 15%, concrete-steel composites to 10% and others, e.g. timber, to 10%. Due to the fact that there are possibilities for different combinations of material types in structural frames, the result of the survey should be seen as somewhat uncertain.

#### 1.1.2 Structural frames of cast in-situ concrete

In Sweden, cast in-situ concrete has been the dominant concept for producing structural frames in multi-family dwellings. However, the method has been criticised for not being as industrialised as competing materials concepts. From a technical point of view, this criticism has been focused on design (short spans), production (low cost efficiency, long production times, non-rational methods, problem-related work environment) as well as building function related aspects (moisture problems, non-flexible solutions for future refurbishment). Many of these problem-areas are related to that the same methods and technologies as used during the last decades still are used within the house-building sector. In order to follow the increasing industrialisation within the construction sector, the use of cast in-situ concrete must be developed further in order to survive (Byfors, 1999). Below, a brief technical description of the today in Sweden used cast in-situ concept for structural frames in multi-family dwellings are presented.

From a design perspective, cast in-situ concrete structural frames for low- medium rise buildings are normally produced either by using steel tunnel-forms for slab or wall casting (see Figure 1.1) or casting the slab on prefabricated thin concrete floor slabs (so called “Filigran”). The thickness of the concrete slab is typically 200 mm (sometimes up to 250 mm), and 160 to 200 mm in inner walls. The building is often furnished with curtain wall facades, which are prefabricated or built on site with studs of sheet steel or wood and cladding of bricks or rendering on mineral wool.

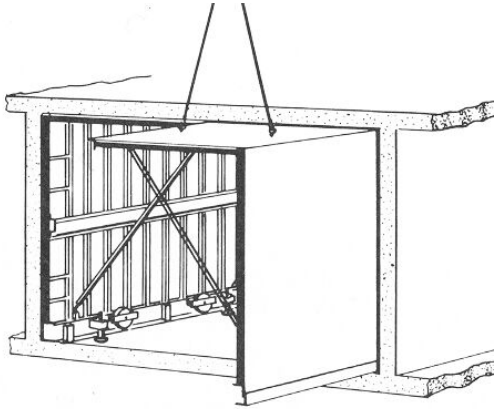

*Figure 1.1 Use of tunnel-form leads to the opportunity for casting both slab and wall at the same time. Figure according to Nilsson (1992).*

The most frequently used concrete type is an ordinary house-building concrete, defined as a mix with a high water/cement ratio (w/c ratio) of approximately 0,60 to 0,70 and concrete compression strength ( $f_{cc}$ ) of about 30 MPa. Generally, the reinforcement is non-tensioned. The relatively low structural capacity due to the average concrete quality and minimum reinforcement, only permits floor spans up to approximately 5 m. Cast in-situ concrete partition walls normally support the slabs to form a solid cell system, which is illustrated in Figure 1.2. This limits flexibility for the customer and the opportunity for future adaptation, compared to other layouts, which are common within the construction of office buildings, such as column-slab layouts and post-tensioned reinforcement. To some extent though, the latter concepts are introduced to the production of residential house-buildings.

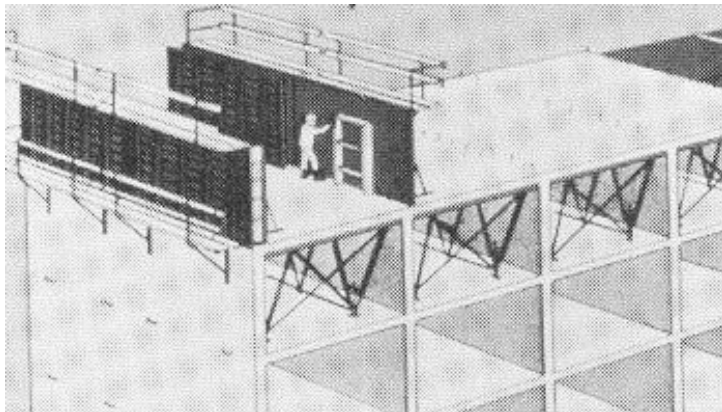

*Figure 1.2 Commonly used type of cast in-situ concrete structural frame where the partition walls, supporting the slab, form a solid cell system, which reduces the future flexibility. Figure according to Nilsson (1992).*

With regard to production related aspects, the high w/c ratio of a traditional low-grade house-building concrete, leads to long drying times before floor coverings can be applied, in order to avoid moisture related problems caused by emission from screeds, glue or carpets. Another example of how such average concrete might affect the production in a negative way, is when cold air temperatures wintertime either extends the time for reaching the required strength for formwork removal, or requires external concrete protection methods (e.g. covering, insulation

and/or heating of concrete) for reducing the required formwork skipping time or avoiding early freezing of concrete. Also, during normal outer air temperatures, the fairly slow strength development of low-grade concrete may lead to non-cost efficient production due to long required times until formwork skipping and/or before post-tensioning of reinforcement can be performed. Ordinary cast in-situ concrete has to be vibrated and compacted with vibrators. The method is manpower-intensive and may lead to hearing impairment and/or vibration injuries (white fingers syndrome).

Both the design and production properties mentioned, concerning cast in-situ structural frames made with ordinary low-grade concrete, affect the function of building. As mentioned, short floor spans combined with concrete partition walls limit future flexibility and refurbishment.

With regard to presumptive future moisture problems, e.g. emissions from carpets or adhesives and mould growth in organic material, Swedish building regulations stipulate maximum allowable values for relative humidity, measured on the equivalent depth of concrete construction (Boverket, 1999). These values depend on the type of material used to cover the concrete floor. For most materials the maximum values are between 85% and 90% relative humidity, which usually requires a drying time of several months for average concrete.

For acoustical purposes, a thick concrete slab is advantageous (Ljunggren, 1995). However, in practice, the thickness of the concrete slab is limited because of the long drying times of normal concrete. Partly for this reason, the highest sound insulation class (in accordance with Swedish building regulations) is seldom reached.

## **1.2 Building process related issues concerning structural frames – based on an interview study**

### **1.2.1 Introduction**

The house-building sector has been criticised for the low level of co-operation between actors, lack of knowledge, poor inclination to innovate, unclear responsibility, inflexible roles and conservative decision-making etc. In Sweden, the Government's Building Cost Commission (BKD, 2000) has criticised the house-building sector for lack of customer orientation, lack of technical innovation, lack of holistic consideration (i.e. integration) regarding design, production and use and lack of co-operation between the actors.

Many of the technical problems due to traditional usage of low-grade cast in-situ concrete within the house-building sector, described above, may be solved if new concrete materials technologies are utilised, see further Chapter 2 "New concrete materials technology (HPC and SCC)". However, there are many obstacles for the implementation of new materials techniques for house building, see further Chapter 6 "Obstacles for the implementation of new concrete materials technology" for more detailed description of both technical and building process related obstacles.

This section aims at describing building process related aspects of house building today, focusing on influencing parameters regarding the choice of structural frame materials, addressing for instance the form of contract and role of actors. The result of the analysis is largely based on interviews with persons representing various actors within the house-building sector (Öberg and Peterson, 2000). The persons interviewed have by their expert

knowledge been selected with the aim of covering relevant areas within the sector regarding planning and production of multi-dwelling buildings. Important to notice is that this section consists of a summary of personal opinions.

### 1.2.2 Influence of the form of contract on the choice of structural frame

The opportunities for different actors to influence the choice of structural frame, is to a large extent dependent on the form of contract used in the particular project. In the *general contract* model the investor in co-operation with the appointed consultants are the decision makers, and they produce the production documents. Thus the possibilities with regard to the influence on design of the building, are very limited for the general contractor inclusive subcontractors and suppliers, see Figure 1.3.

A contract model with some similarities with the general contract is the *divided contract*. The difference is that by the general contract, the general contractor is responsible for production co-ordination while by the divided contract, the investor or the appointed construction management consultant takes this responsibility.

In the case of a *design and build contract* model, there are greater possibilities for the contractor to influence the decision of structural frame and other aspects of the building. The investor provides only principal documents and the contractor is responsible for the production documents, according to Figure 1.1. A design and build contract model also tends to give more opportunity to subcontractors and suppliers, like the ready mix concrete producer, to influence the design.

A special concept closely related to the design and build model is the *own development model*, whereby the investor and the main contractor are within the same company.

#### General contract

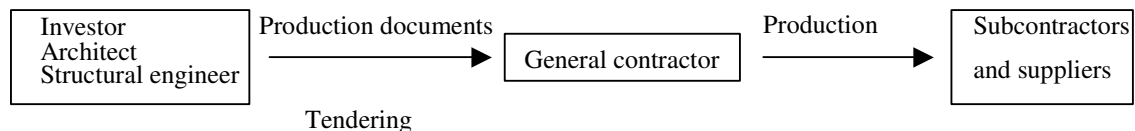

The structural frame is decided

#### Design and build contract

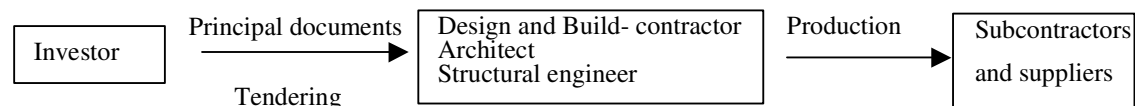

The structural frame is decided

Figure 1.3 The influence of the type of contract model on the design decisions (Öberg and Peterson, 2000).



### **1.2.3 Influence of actors on the choice of structural frame materials**

The building sector has been criticised for being not as industrialised as the manufacturing industry from an organisational and process oriented point of view. The major arguments concern the co-operation between the, in many cases, large number of actors which are involved in building projects. Especially the co-operation between the actors in the early stage of projects, the planning process, is criticised for being less developed compared to the manufacturing industry.

Some state that the house-building sector is conservative and traditional which makes innovations difficult to implement. This can to some extent be referred to the fact that buildings have to be safe and functional for a very long period of time and that malfunction often causes dangerous and expensive consequences.

This section aims at describing the role of the major actors within the building of concrete structural frames, addressing the actors' influence on the choice of structural frame material. The investigated actors within the study are the architect, the structural engineer, the contractor, the ready mix concrete producer and the concrete element producer. The focus is set on these actors regarding co-operation, competence and tradition.

Within the house-building sector, there are some actors in the production process who seldom are involved in the planning process. For example, subcontractors or material suppliers, such as the ready mix concrete producer, do in most cases not co-operate with neither the architect nor the structural engineer. The reasons behind this tradition, its' effects and the possibilities for change will be discussed below.

Today the contract type "own development projects" dominates the production of multi-dwelling buildings. Many persons within the house-building sector believe that this concept promotes a higher grade of co-operation and feedback compared to traditional project forms, especially the general contract. On the other hand, the concept is criticised for being too much focused on the production phase and based on company standards and that the influence of some important actors, especially the architect, may be too small. Many believe that these participants have to break their own traditions if they want to be more active during the whole building process.

Some trends influenced by the manufacturing industry can be seen in the house-building sector today. It is increasingly common that the contractor uses "system thinking" as a strategy, which means that a total concept is taken where different parts of the process are integrated. For example, with regard to single-family houses, the productivity increased with 45% between 1968 and 1997 by integrating the process of design and production, while the corresponding increase for multi-family dwellings was only 15%, (BKD, 2000). It is unclear if the "system thinking" trend will increase in the future and what consequences this will have for building process.

Below, the possibilities of the studied actors for influencing the choice of structural frame will be discussed. As already mentioned, the result is based on personal interviews and therefore will contain subjective points of views.

#### **1.2.3.1 The architect**

Traditionally, the architect has the key role in the planning of building projects and thus the responsibility, with the assistance of structural and technical supply engineers, for the overall

functional and esthetical quality and for the adaptation of the new building into the local environment.

Regarding multi-dwelling buildings, it is increasingly common in Sweden that large construction companies such as JM, NCC and Skanska produce residential buildings as own development projects. See Figure 1.4. With the aim of increasing the productivity, standardised house-building concepts are being introduced. It is generally acknowledged that the productivity issue is important and pressure has been put on the building industry to address this, (BKD, 2000).

Consequently, it is necessary that the standardised concepts are sufficiently flexible and open not to obstruct the freedom of the architect. Furthermore, attention should be paid to the risk that the architect's role could be limited in the context of own-development projects including company based, standardised technical solutions.

In Sweden the architect is primarily involved in the early stages of the building process, a situation different from that in many other countries, where the architect is involved in the whole building process. In Denmark, for instance 1/3 of the architect's work is related to the production phase. Further, an obvious advantage of the architect's increased learning through improved feedback from the production is the safeguarding of the realisation of the overall building quality.

### **1.2.3.2 The structural engineer**

Similar to the architect, the Swedish structural engineer has a rather limited dialogue with the contractor and the material suppliers, such as the ready-mix concrete producer, both in the planning and the execution phase.

There are probably differences in the quality of the dialogue, depending on whether the structural engineer is hired as a consultant or employed in-house by the contractor. The competence in production technique and materials technology is often limited, maybe due to ambiguity of responsibility.

The co-operation between the structural engineer and the contractor on the one hand and the ready mix concrete producer on the other, differs when comparing house building to civil engineering construction. The average structural engineer in civil engineering often practises significantly more advanced concrete technology compared to the structural engineer within house building. In civil engineering construction, there is normally also a frequent dialogue between the actors concerning advanced concrete technology. Many of the persons interviewed mean that this dialogue very often is missing within the house-building sector, where the utilisation of new concrete technology is less valued.

### **1.2.3.3 The contractor**

As shown in Figure 1.4 the contractor's role as a general contractor within house building has more and more been changed into to the role of own development contractor.

By some of the interviewed persons, the own development and the design and build contract models are considered to encourage more production-oriented design and choice of materials. The competence and knowledge of each actor may more easily be shared if there are open dialogues.

It is believed by many of the persons interviewed, that in the previously often used general contract models, the contractor is not able to influence the planning process, which leads the

investor together with the hired consultants to be decision makers within the early stages of house-building projects.

In the design and build contract form though, there are probably increased opportunities for the contractor to influence the planning process. But some of the interviewed persons state that even for this contract form, “system thinking” including feedback and open dialogues with the subcontractors, e.g. the concrete producer, is seldom established.

The interest for and utilisation of new concrete materials technologies, or advanced structural design, has often been low in the ordinary house-building sector, compared to the civil engineering sector. However, with regard to new concepts created within own development contract models, the opportunities for usage of new design, production and materials techniques may be clearer, if the actors are able to have open dialogues during the planning process and feedback in the production phase. These concepts may further increase the utilisation of new technology without focusing on questions concerning, for instance, responsibility, which often is described as a main obstacle today in the implementation of novel technology.

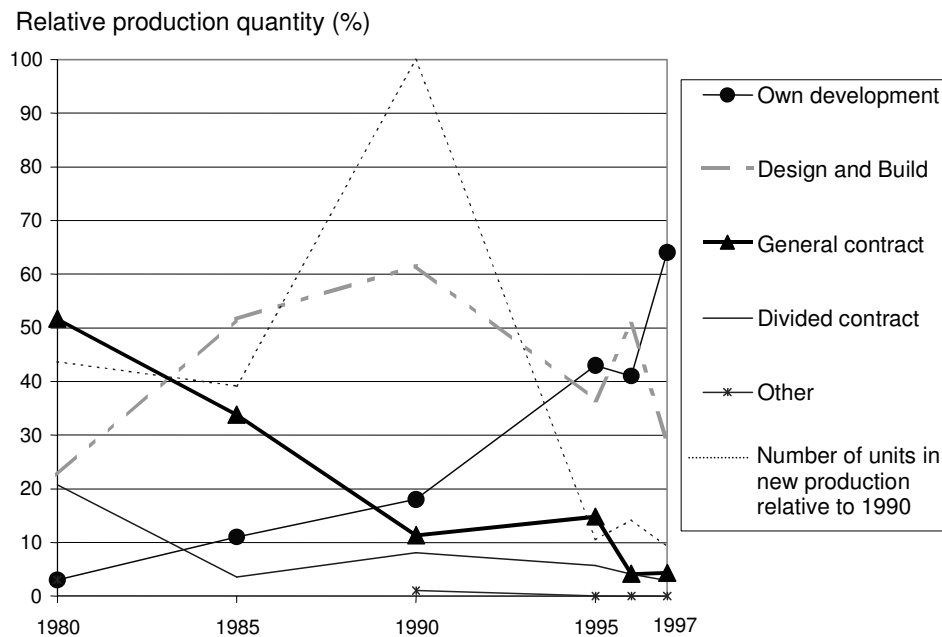

Figure 1.4 Production of multi-family dwellings in Sweden. Contract models' proportion and relative production quantity according to SCB (2000).

#### 1.2.3.4 The concrete supplier

Due to the aim of the research project, special attention is paid to the roles of the ready-mix concrete and concrete element suppliers.

During the so-called “Million Programme” in Sweden 1965-1975, more than 1 million dwellings were produced. Some persons interviewed believe that the huge amount of ready-mix concrete and prefabricated concrete elements that was needed further influenced the attitude of the concrete producers; the ready mix concrete producer did not have to make any big efforts in marketing the product. It was selling itself. The precast concrete industry

developed systems adapted to fit large-scale projects with great repetitiveness, and large precast plants were in operation in the vicinity of the larger cities.

During the time after termination of the “Million Programme” until today, the production of ready mix concrete for the house-building sector, as well as the production of multi-family buildings, has decreased.

However, the way of thinking and traditions, created during the “Million Programme” are still very strong, especially in the parts of Sweden remote from the big city areas and where there is a lower grade of competition between the concrete producers.

The ready mix concrete producers are seldom engaged in the early stages of the house-building process. Due to this fact, it is almost impossible for the concrete producer to influence the planning of house-building projects. In several cases, especially in the low competition markets, the concrete producer is described as being “only a supplier of concrete to the building site”.

The concrete supplier’s co-operation with the architect and structural engineer is almost none. However, during the last years a fairly close co-operation concerning the question of how to control the drying of concrete in order to secure a healthy building has been established. This question often forms a decision criterion for the choice of concrete quality because of the close link to both production time and production costs. Another example of increased co-operation is the implementation of self-compacting concrete, SCC, which has set requirements for a clear dialogue between the ready-mix concrete producer and the contractor. The collaboration between the ready-mix concrete producer and other actors in the building process is normally limited to the contractor and in most cases co-operation starts after the planning process. The potential advantage of interaction in the early stages can be illustrated by the example of the structural engineer making structural use of a high concrete strength, selected in order to meet the concrete drying criteria. The other actors’ technical knowledge is often considered inadequate by the concrete producer, which limits the possibilities to reduce production cost and to increase the technical performance of the building. Spreading knowledge of novel concrete materials technology within the house-building sector may be difficult, due to the sector’s generally low interest in new concrete technique and due to the varying and occasionally also limited technical competence within the concrete ready-mix industry, especially in the low competition markets.

The marketing arguments for the concrete element producer, in comparison to the ready mix concrete producer, partly consist of that the element producer is able to offer a total concept including structural design, which is seldom the case in the concrete cast in-situ alternative. The precast concrete producers can offer more or less complete packages of structural frames including the design and building erection phases. Some producers in Sweden, as for instance SCF Strömsund AB, Skanska Prefab and Strängbetong AB, have developed complete systems for multi-dwelling buildings incorporating not only the structural frame but also finished facades including windows and technical systems for heating and ventilation. To exploit the precast technology properly it is deemed necessary that the precast producer should be engaged early in the project planning process.

One way for the ready-mix concrete industry to increase the co-operation between the involved actors in building of structural frames is to establish organisations, acting both as materials producer, structural engineer and contractor. In the city of Gothenburg the ready mix concrete producer Färdig Betong AB has started co-operation with contractors by forming a structural frame company, and in Stockholm the construction company JM AB has introduced a special structural frame organisation JM Stombyggnad. This seems to be one

way to get more “system thinking” and feedback and clearer definitions of the responsibilities of the different partners involved in the production of structural frames.

#### **1.2.4 Building process related aspects on structural frames – summary and conclusions**

Within the house-building sector, some actors are seldom involved in the planning phases of projects. For example, in most cases subcontractors and material suppliers do not co-operate with either the architect or structural engineer. The opportunity for different actors to influence the choice of structural frame is largely dependent on the form of contract adopted for the project. In Sweden, the production of multi-dwelling buildings is dominated by the use of a form of contract for self-development projects. This form of contract often embodies total concepts, which would promote a higher level of co-operation and feedback, compared to the more traditional general form of contract. On the other hand, the concepts can be criticised for being too focused on the production phase and based on company standards whilst reducing the influence of some actors. In the ready-mix concrete industry, special frame-building companies have to some extent been established, addressing the potential for increasing the market shares by offering complete structural frames through organisations including the roles of both structural designer, concrete supplier and contractor. With regard to the implementation of novel concrete materials technology, this may decrease the uncertainties regarding responsibility and lead to opportunities for increased competence and feedback.

Compared to the civil engineering sector, in house building, utilisation of new concrete materials technologies for the construction of structural frames is limited, due to the traditionally low interest in novel technology and grade of co-operation between the involved actors. This leads to that the potential of concrete cast in-situ structural frames is not fully exploited. During the last decade, new concrete materials technologies such as self-compacting concrete (SCC) and high performance concrete (HPC) have been developed. A more frequent use of these techniques would probably result in advantages in design, production and function of the buildings. See further Chapter 2 “New concrete materials technology (HPC and SCC)”. However, if new concrete materials technology is to be integrated into house building, the tradition of low degree of co-operation between the actors as well as the low interest in developing the structural frame has to be broken.

## Chapter 2

### New concrete materials technology (HPC and SCC)

Concrete materials research is performed extensively around the world. During the past decade, considerable research effort has been put into both high performance concrete (HPC) and self-compacting concrete (SCC). These new technologies have been implemented especially within civil engineering work (e.g. bridges, roads and offshore construction) and in the construction of prestigious high-rise buildings. In Swedish low- medium rise house building, HPC has been implemented to some extent with the aim of reducing the concrete drying times and/or formwork removal time. SCC has been used in attempts to obtain more rational production. But, most cast in-situ concrete is used in the same way and by the same kind of building process organisation as in past decades, despite the increasing competitiveness of other materials like wood or steel.

However, the concrete materials research concentrates mainly on technical aspects. Non-technical aspects concerning, for instance, obstacles to implementation, or incentives, such as economic benefit, are often limited. Some research though, has shown that rationalisation is possible when using new concrete technology. In Sweden, research results show practical advantages and cost savings from the use of HPC – see, for example, Hallgren (1993) and Persson (1996) who describe some of the economic benefits. Commonly though, just one or two aspects are examined in this type of research. A total concept that would highlight the range of opportunities available from using this novel technology is lacking. Indeed, the latter point is a fundamental issue for construction process improvement and forms the primary aim of the research project.

By utilising novel concrete materials technology, the technical disadvantages of ordinary low-grade house-building concrete for the construction of cast in-situ concrete structural frames, according to Chapter 1, can be countered. This chapter aims at describing the concrete materials technologies HPC and SCC, describing international research, materials characteristics and utilisation areas. Besides, it briefly describes the potentials with regard to design, production and function of structural frames in multi-dwelling buildings as well as obstacles (both technical and organisational) for implementation.

## 2.1 HPC

### 2.1.1 HPC – history

#### 2.1.1.1 International research and experience

In the 1980s, concrete with silica fume in combination with super-plasticisers was developed to give increased strength, thereby creating new possibilities for concrete structures such as columns in high-rise buildings (Walraven, 1999). This new material was termed high strength concrete (HSC). However, the concrete had other properties such as high durability, and was used in other kinds of construction, for instance in offshore. These new properties led to the name being changed to that of high performance concrete (HPC). The benefits of HPC lead to opportunities for its' utilisation within a range of applications. During the 1990s, research and applications of HPC have increased dramatically (Helland, 1996). Over the past few years,

HPC has been common in offshore construction, bridges, tunnels, roads and high-rise buildings worldwide. Helland (1999) argues that the concrete sector has changed from a low-tech to a high-tech sector and must continue to develop and implement novel concrete materials technology in order to compete with other materials. According to Walraven (1993), the conservative construction sector has to extend international building codes and get accustomed to the idea of using HPC. Increased knowledge in new materials technology may be necessary for designers, if the new materials are to be fully exploited and their potential risks are to be properly handled (Walraven, 2000). Helland (1996) further argues that international codes must follow technical development in order to avoid major step changes.

Regarding house building, international research on HPC concentrates mainly on high-rise buildings. In the US, HSC was at first used in columns in high-rise buildings to achieve greater height and stiffness and to reduce column sizes (Russel & Fiorato 1994). Hoff (1993) gives an overview of HPC in high-rise buildings constructed in the US before 1992. In Asia, the use of HPC in Japan is described by Ikeda (1993), in Singapore by Chew (1993) and in China by Chen & Wang (1996). Incentive for using HPC in high-rise buildings in Asia has been its' high degree of earthquake resistance (Jinnai, 1999). In summarising the use of HPC in high-rise buildings, the incentive in most cases has been the increased strength of concrete columns, allowing greater height and larger floor area.

#### **2.1.1.2 Swedish research and experience**

A major Swedish research programme on HPC was during the years 1991-1997 conducted by Swedish companies, institutes and universities. The programme was financed both through an industry consortium and through governmental funding. The main result is presented in two handbooks, one on material performance and one on the design of HPC (Swedish Building Centre, 2000a, 2000b). The results cover a wide range of research areas but also detailed information regarding technical aspects. The most relevant research concerns concrete production, material properties (strength, deformation, durability) and structural analysis. Hardly any of the result covers economic or utilisation-related aspects.

In Sweden, like the rest of world, HPC has been implemented mainly within civil engineering works. There are many examples of how the increased durability of HPC (due to the increased denseness of the material structure) has been utilised within the construction of bridges, tunnels etc. Another incentive for using HPC within the civil engineering area is the advantages through reduction of dead load and the possibilities for reduced material volume and/or increased bearing capacity. Also, from a production related point of view, HPC has been utilised for earlier formwork stripping, early post-tensioning of reinforcement and reduction of problems connected to winter casting.

However, within the Swedish house-building sector, HPC has been utilised mainly for reasons related to moisture-related problems. HPC with low water/cement ratio has been utilised through its' self-desiccation properties. However, the automatically increased bearing capacity of concrete with low water/cement ratio is seldom utilised. To a small extent HPC has also been chosen for more rapid production cycles, especially during wintertime. Compared to the international utilisation of HPC in high-rise buildings, Sweden has very few examples, due to the fact that these types of buildings historically are very rare in Sweden, even in the big city areas. During the last years though, a small number of high-rise building projects have been executed and some presumptive projects are in the planning phase.

Whether the utilisation of HPC will be increased for these types of building is somewhat uncertain.

## 2.1.2 HPC – some important properties compared to NPC

High performance concrete addresses function-related aspects. The most commonly required function of HPC is the increased compression strength and, as already mentioned, the former name was high strength concrete (HSC). However, concrete with a high level of compression strength often includes a number of other properties with increased performance, e.g. more rapid strength development, higher tensile strength and elastic modulus, increased self-desiccation and a more dense structure. These properties create opportunities for further increased functions with regard to other aspects than pure compressive strength. According to the Swedish nomenclature, HPC might be defined as concrete with cube compression strength of more than 80 MPa or more and a water/cement ratio (w/c ratio) of 0,40 or less. The definitions concerning HPC differ around the world.

### *Compression strength*

The compression strength, as well as many other properties of HPC, derives mainly from the low w/c ratio, which is reached by increasing the amount of cement and/or reducing the water content by water reducing admixtures. Below, Figure 2.1 shows the relation between equivalent w/c ratio (regard is taken to that 1 kg of silica fume corresponds to 2 kg of cement) and compression strength, determined on 100 mm cubes at 28 days age. The reason for the spread in the result is that different types of aggregate were used in different mixes and that the compaction degree varied. The quality of the measurement equipment and the test procedure may affect the result. The smoothness of the surfaces significantly influences the result. Improper grinding of the plate surfaces may lead to a significant reduction of the estimated concrete strength.

### **Compression Strength, MPa**

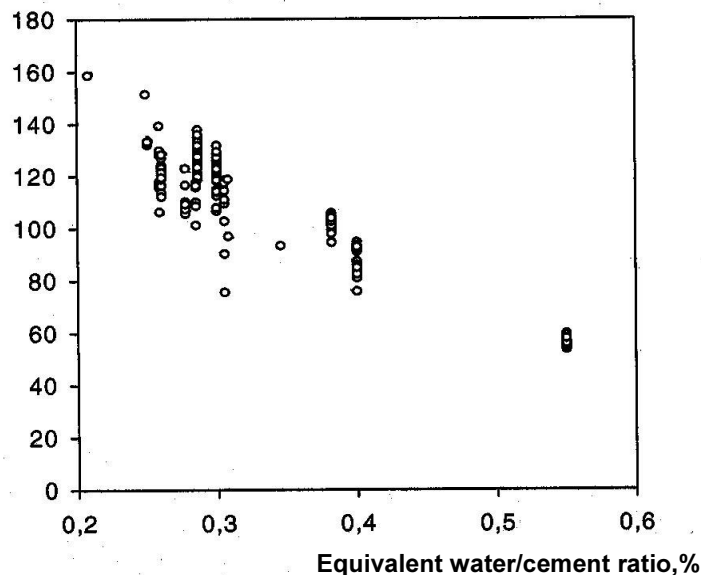

Figure 2.1 Concrete cube compression strength at 28 days age as function of the equivalent water/cement ratio (Hassanzadeh, 2000), based on work by Hassanzadeh, Gabrielsson and Claesson.



### *Tensile strength*

The tensile strength is not increasing linearly with the compression strength of concrete. According to the Swedish building regulations, an increase of the compression strength from 30 to 80 MPa only permits an increase of the characteristic tensile strength from 1,6 to 2,5 MPa, if special investigations are not able to verify a higher value. Several laboratory studies though show that the tensile strength may be increased to approximately 7 MPa. See Figure 2.2 below, which displays the interaction between splitting tensile and compression strength (100 mm cubes, 28 days age). The spread of the result is probably based on the variety of used aggregate and differing types of concrete samples (Hassanzadeh's data corresponds to 100x200 mm cylinders, Gabrielsson's data to 100 mm cubes and Claesson's data to 150x300 mm cylinders).

### **Splitting tensile strength, MPa**

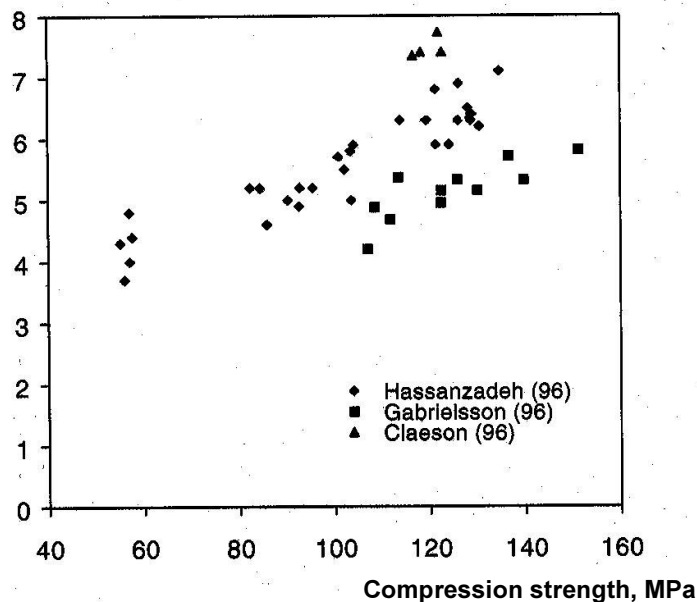

Figure 2.2 Concrete cube and cylinder splitting tensile strength as function of cube compression strength (Hassanzadeh, 2000).

### *Deformation (Elastic modulus)*

Similar to the tensile strength, the elastic modulus (E-modulus) of concrete does not increase linearly with the compression strength. Increased compression strength leads to a rather limited increase of the elastic modulus. According to the Swedish building norms, it is allowed to utilise a characteristic E-modulus of 30 GPa for concrete corresponding to a strength class of K30 (cube compressive strength). Of the maximum allowed concrete strength class of K80 the allowed E-modulus is limited to 38,5 GPa. As with the tensile strength, the Swedish norm allows higher value of the E-modulus if special investigations are conducted. A method for increasing the E-modulus is utilisation of aggregate with high E-modulus. Several laboratory studies show that a value of approximately 50 GPa can be used if aggregate of type diabase is used. See Figure 2.3 below, which presents the elastic modulus of concrete as function of the concrete cylinder compression strength (Hassanzadeh, 1998).

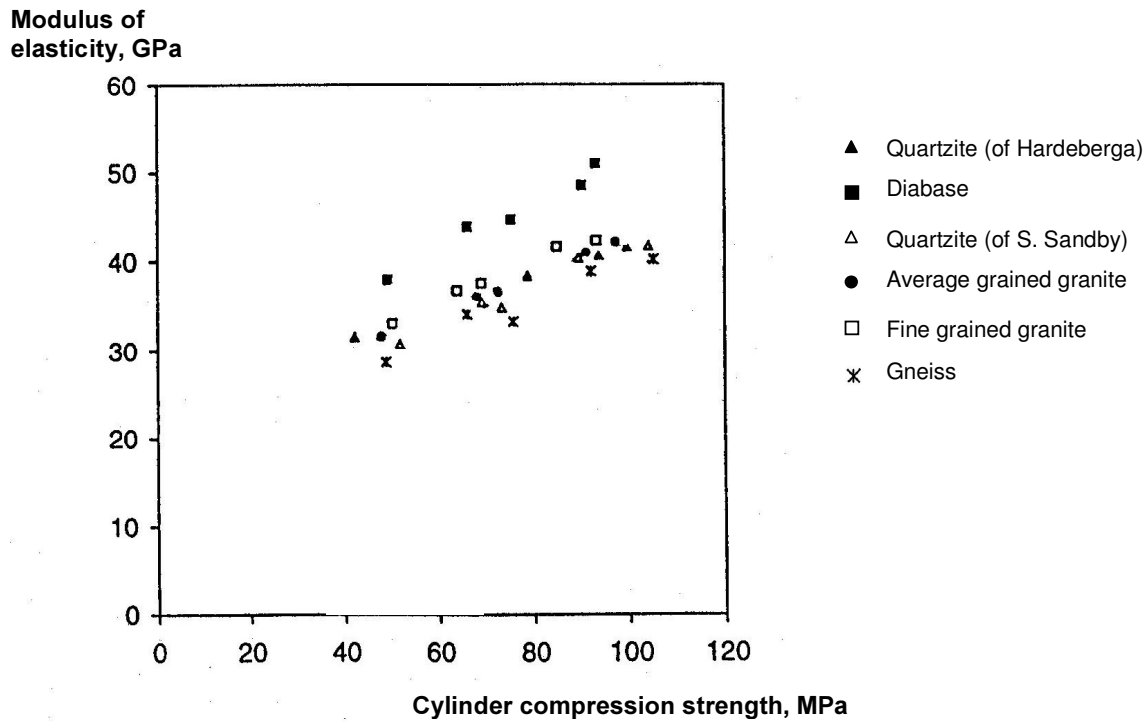

Figure 2.3 Elastic modulus of concrete as function of cylinder compression strength for various qualities of aggregate (Hassanzadeh, 1998).

#### Autogenous shrinkage

According to Figure 2.4 below, HPC leads to larger autogenous shrinkage (shrinkage without moisture loss), than NPC. This depends on the self-desiccation occurring in concrete with low w/c ratio.

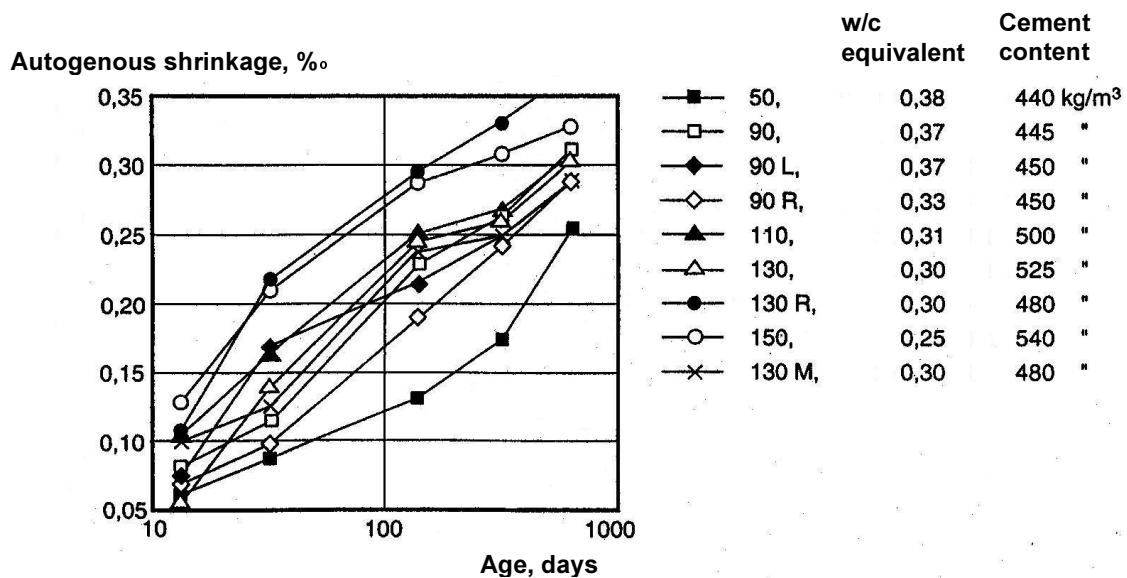

Figure 2.4 Autogenous shrinkage as function of age of maturity.  $f_{cc}(28)=50-150$  MPa, according to Persson (2000).

*Drying performance, self-desiccation effect*

The drying process for HPC also differs significantly from that of ordinary concrete (Persson, 1998). In HPC there is a significant self-desiccation caused by cement hydration. Self-desiccation also occurs in NPC, but in HPC it also causes a lowering of the w/c ratio. This depends on the shape of the sorption isotherm curve, which for HPC is significantly more flattened than for NPC, see Figure 2.5. For HPC, a self-desiccation of 25% of the moisture content ( $W_n$ ), leads to a RH level of approximately 70%. Compared to NPC, the same level of self-desiccation only reduces the RH level to approximately 96%.

**Moisture content, kg/m<sup>3</sup>**

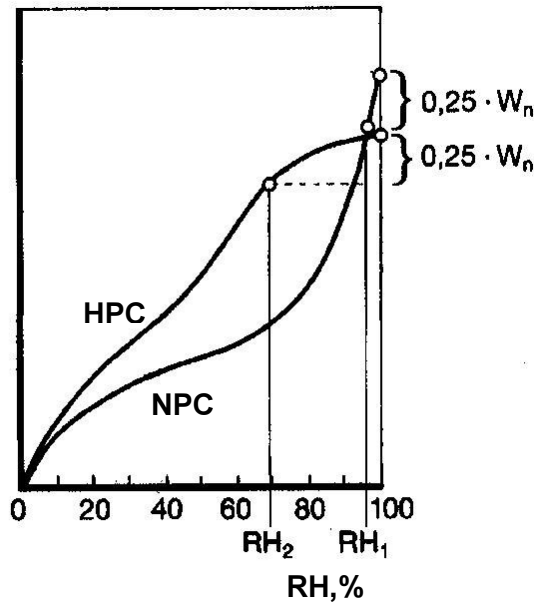

Figure 2.5 Sorption isotherm of HPC compared to NPC (Fagerlund, 1994)

Self-desiccation of HPC reduces the required time for reaching the desired RH level. Figure 2.6 displays the correlation between w/c ratio and the required drying time for reaching 85 and 90% RH on 36 mm depth from the surface in a 180 mm concrete slab with two-sided drying. Note that two of the concrete types include 5% of silica fume (market with “Si”), which further increases the drying effect. The cement is a Swedish high-alkali OPC (Slite Std).

**Approximately drying times  
to reach 85 and 90% RH**

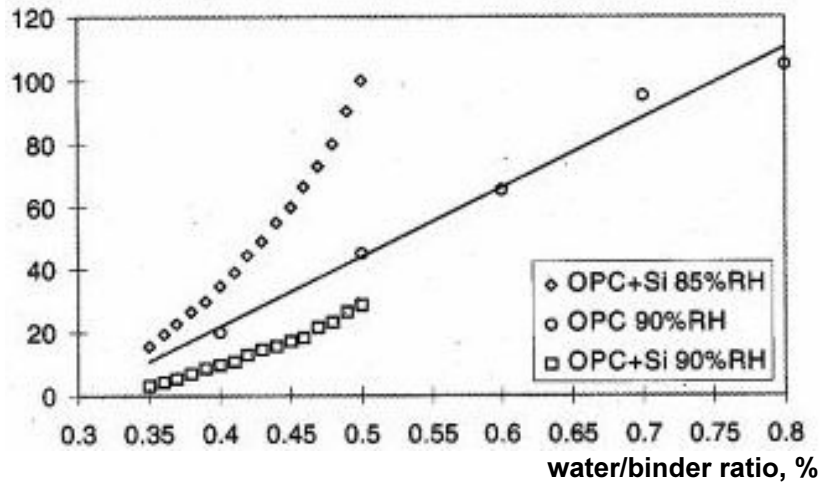

Figure 2.6 Drying time as function of w/b ratio (Hedenblad, 1996).

**Rapid strength development**

Compared to NPC, HPC gives significantly more rapid strength development, due to the low w/c ratio and high amount of cement. Figure 2.7 shows strength development curves for different concrete strength classes. Time is expressed in terms of maturity time at +20°C. The curves are valid for the Swedish cement type “Std Degerhamn”, which is a low-alkali sulphate resistant cement. The strength development of concrete with Swedish OPC is more rapid. For a K40 concrete, approximately 180 hours is required, compared to a K120 concrete, which requires approximately 30 hours.

**Compression strength, MPa**

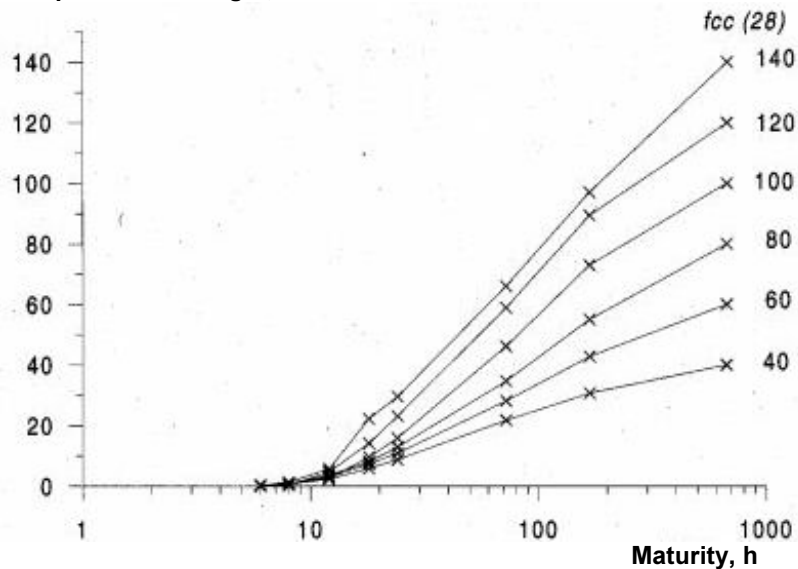

Figure 2.7 Concrete compression strength as function of the age of maturity for various concrete strength classes (Emborg, 2000). Maturity is defined as the curing time at +20 °C.

### *Other important properties of HPC*

- Service life (durability)  
The dense structure of HPC creates opportunities for increased service life of concrete structures.
- Environmental aspects  
When it comes to energy consumption, the negative effects of increased cement content of HPC may be partly balanced by decreased volume of concrete if the increased load- carrying capacity is considered. When estimating the energy consumption of buildings, it is important to consider the total service life consumption, which is assumed to consist of 85% during the usage phase and 15% within the production phase (also including the manufacturing of building materials). HPC creates opportunities for further increased building function related energy savings, see Chapter 5.4 “Decreased energy-consumptions by utilisation of HPC“.

The described properties of HPC, derived largely from its’ low w/c ratio, allow increased function and more efficient production of concrete structures. The list below briefly displays correlations between technical properties and main potential function areas of HPC. Further descriptions of the various beneficial functions are presented in the next sub section, 2.1.3 HPC – benefits (generally).

- |                                       |                                       |
|---------------------------------------|---------------------------------------|
| • High compression strength (28 days) | – improved design                     |
| • High tensile strength (28 days)     | – improved design                     |
| • High elastic modulus                | – improved design                     |
| • Dense structure                     | – improved serviceability (ductility) |
| • Self-desiccation                    | – more efficient production           |
| • Rapid strength development          | – more efficient production           |

### **2.1.3 HPC – benefits (generally)**

As mentioned, within the international house-building sector, HPC is to the largest extent utilised for the production of high-rise buildings. The high compression strength of HPC provides opportunities for HPC-columns to increase the building height and/or reducing materials costs. Occasionally, the fast strength development of HPC is utilised for rapid production cycles.

This sub section describes generally the potential benefits of HPC in low- medium rise house buildings. The section is divided into three parts: structural design, production and building function related benefits of HPC for house building. For further details, see chapters 3, 4 and 5, which present conducted studies of presumptive benefits.

#### **2.1.3.1 Structural design related potential of HPC**

For low- medium rise buildings, HPC enables three main benefits compared to NPC, from a structural design related perspective:

- Increase of slab spans

- Reduction of amount of concrete material
- Reduction of amount of reinforcement

To increase slab spans by using HPC, it is necessary to utilise the potentially higher tensile strength and/or E-modulus of HPC, compared to NPC. A high value of the concrete compression strength itself does not significantly affect the possibilities for increased slab spans to large extent, neither with regard to the ultimate nor the serviceability limit state. The conducted structural design study (see Chapter 3) using increased values of tensile strength and E-modulus, presents a significant potential of HPC for increasing slab spans, both for slab/wall and slab/column structures. For instance, the span for slab/wall structures can be increased by 20% and slab/column structures by 50% when the tensile strength is increased from 2,5 to 5,0 MPa. The same comparison but with regard to an increase of the E-modulus from 30 to 50 GPa results in increase of 15 and 15%. These possibilities of increasing the span are based on non-stressed reinforcement. If post-stressed concrete is used, the span can be further increased due to the high compressive strength. This possibility has not been investigated in the project.

The potential for increased slab span also creates opportunities for reducing the slab thickness and/or reducing the reinforcement amount if the slab span is not increased. Especially concerning slab/column structures there is a significant potential if regard is taken to the risk for concrete punching, which often is managed by increase of concrete thickness and/or increase of reinforcement.

Another advantage of HPC, both from perspectives of structural design and production, is the self-desiccation effect. This enables a significantly faster drying process for HPC than NPC. Furthermore, in HPC the drying time becomes more independent of the concrete thickness, which for NPC may be a critical factor, due to the heavy extended drying and production time. In other words, it is possible to produce thicker structures without any extended drying times if HPC is utilised.

To summarise, HPC has potential for producing larger spans or slimmer constructions for low- medium rise house buildings, as well as reducing the amount of reinforcement and/or concrete material amount.

### **2.1.3.2 Production related potential of HPC**

#### *Fast drying*

From a production perspective, the reduced drying time of HPC, by utilisation of the self-desiccation effect, allows floor coverings to be applied earlier. According to Swedish praxis, a relative humidity (RH) level of 85 or 90%, measured on the equivalent depth in the concrete structure, is required for many often-used floor-covering materials. Equivalent depth is the depth from the drying surface of which RH has the same value as will appear after long time on the bottom side of a flooring material that is 100% impermeable to moisture. Chapter 4 aims at investigating the production related potential of HPC. The results present large differences in drying time required for reaching 85 and 90% RH for different concrete qualities, formwork-systems, slab thickness, surrounding climate conditions etc. For instance the results shows that a concrete slab needs 15 months of drying time for reaching a RH-level of 85% when NPC is used, compared to 3 months if a certain type of HPC is utilised, for the

same conditions, see Figure 2.8 below. This advantage of HPC gives opportunities for both shorter total production time and lower production cost.

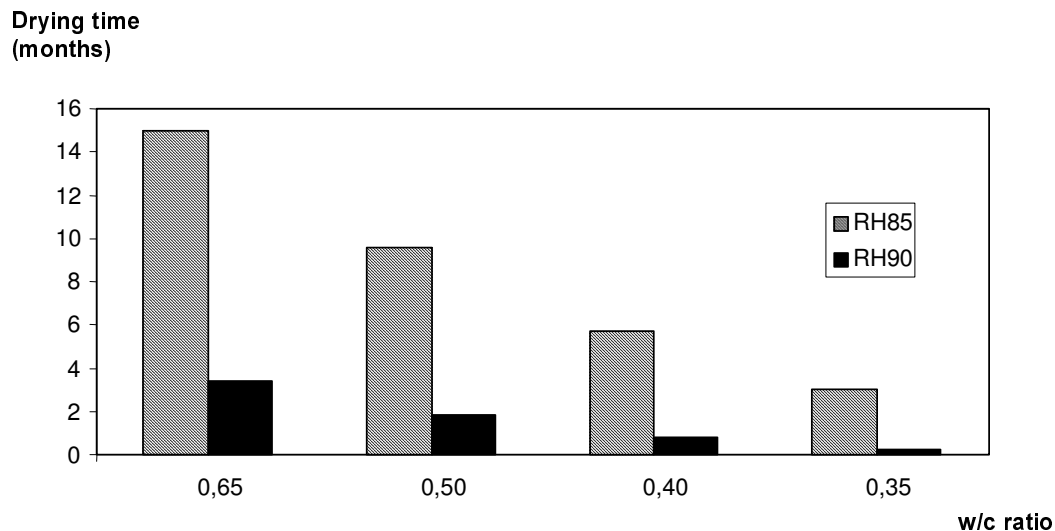

Figure 2.8 Required drying time for reaching 85 and 90% RH at the equivalent depth (for definition, see above) as function of w/c ratio. Data from Chapter 4. The result is based on calculations by the PC-program TorkaS 1.0 (1998). Conditions are slab thickness 0,20 m, double-sided drying and controlled drying climate (air RH 60% and air temperature 18 °C) from the start of casting.

#### *Rapid strength development*

The *fast development* of strength of HPC can be utilised for reduced production time and cost, through decreased time for reaching the minimum strength value required for formwork removal etc. This enables rational use of formwork systems and shorter production cycles. Also, for post-tensioning of reinforcement, the time for reaching the required minimum strength level can be reduced. Especially during wintertime the rapid heat and strength development of HPC can be used for reduction of problems with early freezing and long form-skipping time. According to the second part of Chapter 4, which presents the result of a study aiming at estimating the benefits of HPC regarding rapid strength development, an increase of the cement content also significantly reduces the risk of early freezing of the concrete structure, (Fagerlund *et al.*, 1999). Not only can the costs for reduced production time be decreased. There are also the opportunities for cost-savings by reduction or elimination of winter concrete protection methods such as covering, insulating and heating of the concrete. Figure 2.9, below, presents result from the production study of Chapter 4 and displays the estimated time for reaching compression strength of 20 MPa as function of various concrete qualities, with regard taken to three kinds of surrounding climate.

## Required time (days)

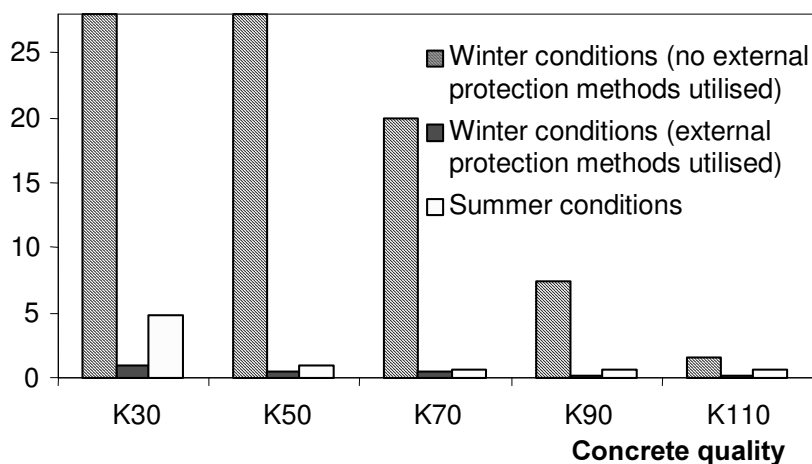

Figure 2.9 Required time to reach a concrete compression strength of 20 MPa as function of various concrete qualities, with regard taken to three kinds of surrounding climate. The result is based on calculations according to the production related study of Chapter 4 through the PC-program Hett 97 (1997), which estimates the heat and strength development of concrete structures with regard to various climate conditions and production methods. By winter conditions means  $-5^{\circ}\text{C}$  air temperature and summer conditions  $+15^{\circ}\text{C}$  air temperature. In the calculations, used protection methods are covering, heat insulation of form and heating of concrete by infra heaters. Slab thickness 0,20 m. Plywood form 19 mm. Concrete temperature at casting during winter is  $+15^{\circ}\text{C}$ . See Chapter 4 for further details.

### 2.1.3.3 Building function related potential of HPC

HPC also provides advantages concerning the function and use of the building. Larger spans in combination with light, easy dismountable, partition walls allows a higher grade of flexibility through increased rebuilding possibilities. Concerning the fast drying process, an advantage may also be the possibility to, in a rational way, avoid moisture related health problems that sometimes have been blamed on inadequate drying time before floor covering. The self-drying effect can also be used to improve acoustic qualities by allowing thicker slabs without any extended production time. Thicker slabs also allows for increasing the free span between walls and columns.

Chapter 5 further describes the building function related benefit of HPC.

### 2.1.4 HPC – obstacles (generally)

There have been obstacles for utilising HPC, from technical as well as organisational and economical perspectives. Many of the impediments for exploitation of HPC have been managed, for instance through research and development of the technology and in combination with feedback from successful projects. However, there are still implementation problems to solve, especially within the low- medium rise house-building area. This section briefly describes the obstacles for HPC within house building in Sweden. See Chapter 6 for further detailed descriptions.



### **2.1.4.1 Technical obstacles**

Technical obstacles for the implementation of HPC concern both the production of ready-mix HPC with regard to the quality of ingredient materials (cement, aggregate, admixtures) and the requirements for increased quality control of the ready-mix concrete process. Besides, there might be technical performance problems of the fresh and hardened concrete on site. The list below displays three main areas of obstacles and issues for implementation of HPC. Also, solutions to these main obstacles, based on novel research, are exemplified.

- Ready-mix concrete production (development of new cements and admixtures, investigations of the availability of high-quality aggregates, development of methods for mix-proportioning)
- Fresh concrete (e.g. development of methods for studying workability and stiffening of the concrete mass)
- Hardened and hardening concrete (increased knowledge of mechanical, physical and chemical properties)

### **2.1.4.2 Obstacles with regard to the building process**

In comparison to the technical obstacles, many of the building process related problems for utilisation of HPC are still unsolved, mainly within the house-building sector. The main obstacles for increased utilisation of HPC within house building are:

- Conservatism
- Lack of knowledge and low interest for innovations
- Missing feedback between the actors
- Unclear responsibility
- Limits within the building codes
- Economy issues focused on direct materials costs and not the total life cycle for buildings
- Sub-optimisation (no regard taken to multi-benefits)
- Pricing of HPC (criticised product costs with regard to “true” materials costs)
- Added costs to HPC due to the high quality (added controls etc)

## **2.2 SCC**

### **2.2.1 SCC – history**

#### **2.2.1.1 International research and experience**

Self-compacting concrete (SCC) is based on new types of highly efficient water-reducing admixtures combined with high filler contents, e.g. limestone or special fine-grained sand. The main advantage of SCC is that compacting work with vibrators can be eliminated. Research into SCC started in Japan in the 1980s. The intention was to manage durability problems caused by insufficient compacting of concrete (Okamura & Ouchi, 1999). The first prototype mixes became available in 1988 and made concrete casting possible without vibration. This material was, in fact, named high performance concrete. In Japan, the

definition HPC includes self-compacting concrete. Over the past few years, SCC has been introduced progressively around the world but the amount of work is still only a fraction of total concrete production. In 1997, SCC amounted to a mere 0.1% of the total production of ready-mix concrete in Japan (Ouchi, 1999).

### **2.2.1.2 Swedish research and experience**

No major national research programme, like that performed on HPC, has been conducted on SCC in Sweden. However, Swedish research on SCC has been carried out since the middle of the 1990s. The first full-scale project including SCC, a road bridge, was carried out by the Swedish National Road Administration in 1998. Incentives for utilising SCC within this project consisted mainly of potentially improved strength, assumed increased service life, better aesthetic quality and higher cost-efficiency (Skarendahl, 2001). The project was successful and resulted in a number of projects where SCC was used with the aim of eliminating vibration work, since this is personnel demanding and causes work environmental disadvantage when used for cast in-situ concrete. SCC also causes high-quality concrete surfaces with less finishing-work as result. Within both the civil engineering and house-building sector, the use of SCC has increased in Sweden during the last five years and has been regarded as one of the most important technical innovations for a more rational way of building with cast in-situ concrete. There are also projects where SCC has led to technical problems, as for instance concrete segregation with non-satisfying surfaces as result, concrete cracking due to plastic shrinkage and form failure due to high form pressure. An extensive development and utilisation of new concrete additives has taken place, and on the Swedish market, several SCC-concepts are practiced. It is believed that further research on SCC is required to secure a robust and fully satisfying product. In a recent report on SCC, published by the Swedish Concrete Association (2002), properties, research, recommendations etc, are presented. Required research areas and the organising of a presumptive national SCC research programme are also described by Emborg (2002). According to the report of the Swedish Concrete Association, the following areas exemplify where SCC-research is ongoing in Sweden:

- Filler effect (increased strength for the same w/c ratio)
- Form pressure
- Shrinkage
- Cracking
- Quality of concrete surface
- Separation
- Stiffening and tixotropy

See 2.2.4 “SCC – obstacles (generally)” and 6.1.2 “Technical obstacles for the implementation of SCC” for further descriptions of technical issues concerning SCC.

### **2.2.2 SCC – technical properties**

Ordinary concrete requires external compacting work by internal or external vibrators for proper compaction of the concrete, filling the form and covering the reinforcement. In order to create the self-compacting effect of SCC, which eliminates the need for vibration work, the friction between the particles needs to be reduced, plus, the stability of the fresh concrete has

to be managed. This can be done by utilising a high content of filler (particles < 0,125 mm) together with high-efficient super plasticising and/or viscosity increasing additives. High filler contents, e.g. lime stone or glass filler, increase the viscosity of the water phase, which aims at keeping larger particles suspending and further avoiding concrete separation. Super-plasticisers aim at increasing the dispersing-effect and further decreasing the friction between the particles.

There are several concepts for producing SCC. The most frequently used concept consists of a combination of very efficient additives and limestone filler together with increased cement content. Alternative concepts often contain other types of filler, as for instance glass filler, or no filler at all. Below, three different kinds of mix-concepts for SCC are presented, of which the first one, that contains both super-plasticiser and filler, is the most commonly used in Sweden:

1. SCC based on super-plasticiser (dispersing) and filler  
A proper mix of particles, water and super-plasticiser may result in satisfying stability, viscosity and flow. The balance between flow and stability is very important. The filler properties affect the stability and viscosity and the super-plasticiser affects the flow performance.
2. SCC based on super-plasticiser and viscosity increasing admixture combined with reduced amount of filler  
Utilisation of additives, which increase the viscosity, leads to that the required amount of filler is reduced. However, this concept requires a finer gradation curve of the gravel than concept 1.
3. SCC based on super-plasticiser and viscosity-increasing admixture  
In this type of SCC, stability is achieved by the viscosity-increasing admixture. No filler is required. The balance of the additives is very important and in practise hard to manage.

Various new types of test methods are developed in order to measure important properties of the fresh SCC, for example, the L-box, slump flow test (w/wo T50), Tixomethod, J-ring and V-funnel. SCC requires increased testing on the ready-mix plant as well as on the building site, in order to verify that the required self-compacting ability and stability of the fresh concrete are achieved.

## **2.2.3 SCC – Benefits**

### **2.2.3.1 General**

With SCC there are new possibilities concerning design. For instance, densely reinforced structures, which are difficult or impossible to produce according to traditional production methods, can now be produced.

SCC is also a solution to problems with work environment. White fingers on concrete workers will be eliminated and the building site will be significantly more silent without the noise from concrete vibrators. Furthermore, the elimination of the vibration means rationalised casting technique with need of less personnel and presumptively reduced production costs.

Smooth, high quality surfaces can be produced directly without the expensive finishing work often needed when concrete is cast traditionally.

The two main beneficial areas of SCC therefore are:

- Improved work environment and increased productivity
- Possibilities for designing more advanced concrete structures with more densely spaced reinforcement

### **2.2.3.2 Production related potential of SCC**

Mizobuchi *et al.*, (1999) have described SCC as one of the most innovative developments in the field of concrete technology. Byfors (1999) discusses the use of SCC in the context of the industrialisation of cast in-situ concrete, which eliminates compaction work. There are many advantages in using SCC, not least the improved work environment. The elimination of vibration work leads directly to a reduction in manpower on job sites. It accelerates the production process and improves quality, durability and reliability of concrete structures, all of which generate cost savings (Grauers, 1999). Smooth, high quality surfaces can be produced directly without expensive finishing work, which is often needed when casting concrete traditionally. Also, the proportion of heavy work is reduced and job sites can be significantly quieter without the noise of concrete vibrators: this is an advantage both for safety on site and for the neighbourhood.

### **2.2.3.3 Design related potential of SCC**

There are also opportunities for designers. For instance, densely reinforced structures, which are difficult or even impossible to construct using traditional methods, can be achieved with SCC. One example is the design of the Millennium Tower in Vienna, which is described by Pichler (1999) as impossible to build without SCC.

## **2.2.4 SCC – obstacles (generally)**

### **2.2.4.1 Technical obstacles**

Compared to HPC, there is a wide range of unsolved technical issues connected to SCC. These technical obstacles for the implementation can be generally divided as follows:

- Problems related to the production process of ready mixed SCC (e.g. control of mix ingredients)
- Problems related to fresh concrete (segregation, form pressure etc.)
- Problems related to hardened concrete (variety of the quality concerning concrete surfaces and covering of the reinforcement, cracking etc.)

See 6.1.2 “Technical obstacles for the implementation of SCC” for further descriptions of technical issues concerning SCC.

#### **2.2.4.2 Obstacles with regard to the building process**

Obstacles for SCC related to the building process are principally similar to those for HPC, and to the impediments for technical innovations in general within the house-building sector.

- Conservatism
- Lack of competence and low interest for innovations
- Missing information-spread and feedback between the actors
- Unclear responsibility (increased responsibility for the concrete supplier due to elimination of the traditional compacting work by the contractor)
- Risks of concrete workers losing their jobs due to less personnel requirements
- Economy issues focused on direct materials costs instead of total project cost
- Pricing of SCC (criticised product price compared to “real” materials costs)

## Chapter 3

### Structural potential of HPC within house building

#### 3.1 Introduction

##### Background

Concrete structural frames are sometimes criticised for leading to short slab spans and limited grade of flexibility concerning future adaptation. The criticism is based on the fact that the frame is built of traditional low-grade, cast in-situ house-building concrete, in combination with supporting concrete partition walls. Other criticism concerns the long drying times that lead to extended production times, moisture problems, and specific complications and costs when casting during winter conditions.

The low w/c-ratio of HPC gives higher and more rapid strength development, but also increased elastic modulus and self-desiccation effect. These properties create advantages in structural frames from design, production and building function related point of views.

HPC has been utilised internationally in high-rise buildings during the 90s. The incentives have been higher bearing capacity that leads to taller buildings and slimmer constructions. Within the Swedish house-building sector, HPC has to some extent been used with the aim of shortening the concrete drying times, by utilising the self-desiccation effect. To a minor extent, HPC is used in Sweden because of its' rapid form removal times and/or less winter casting problems. But the incentive for using HPC in house building in Sweden has seldom been its' larger bearing capacity.

If the described benefits of HPC are to be gained, various obstacles have to be managed. There are technical, economical and building-process related obstacles for a higher grade of utilisation of HPC in the production of multi-dwelling buildings in Sweden. Benefits from many points of view probably must be taken into account if disadvantages, as for example higher materials costs, are to be accepted. Therefore it is motivated to focus on the *structural design related* advantages of HPC, which is an often forgotten area in the house-building sector.

##### Aim

The aim of the study is to investigate the potential of HPC in house building with regard to *structural design*, e.g. increased spans and decreased slab thickness. Besides, the amount of reinforcement in HPC is analysed.

By input of "real" measured concrete materials data (compression and tensile strength, elastic modulus and creep ratio), different kinds of slab types are calculated without paying attention to economical or production related effects (e.g. large amounts of reinforcement and high aggregate quality requirements).

The result of the calculations is aimed to show the structural design potential of HPC. This forms the basis for further analysis of synergy effects with regard to the production and the function of the building.

## Method

Finite element methods (FEM) are conducted by using the PC-program FEM Design Plate (2000) developed by “Skanska IT Solutions”. For calculations in the *ultimate limit state*, different kinds of spans are simulated, and the required reinforcement with regard to maximum moment for each kind of slab type is calculated. Regard is taken to punching when column/slab structures are used. Variables in these calculations are: the characteristic compression strength (21,5 and 56,5 MPa, corresponding to the Swedish K30 and K80 respectively), the characteristic tensile strength (1,60, 2,50 and 5,0 MPa corresponding to K30, K80 and HPC with increased tensile strength) and the slab thickness (0,20 and 0,24 meters). The theoretical amount of reinforcement based on the real varying moment of entire slab sections has also been calculated by summing up the calculated amount of reinforcement in each FEM node and thereafter calculating the average value.

In the *serviceability limit state*, maximum displacement has been calculated and compared to the maximum allowed deformation criteria. This method provides the maximum allowed spans with regard to deformation. The variables are: the characteristic compression strength (same values as defined above), the characteristic tensile strength (same values as defined above), the slab thickness (same values as defined above) *and* the elastic modulus (30, 40 and 50 GPa) and creep ratio (0 and 2). For further description of the method of calculation, see section 3.3 “Structural calculations” and Appendix A.

## 3.2 Slab constructions – general conditions

### 3.2.1 Concrete parameters

With the aim of estimating the structural design related *potential* for HPC in house building, the effects of a number of concrete parameters are theoretically estimated through finite element calculations. As mentioned in the introduction of the chapter, the structural potential mainly means the opportunity for increasing the slab spans.

#### *Concrete compression strength*

To define significant concrete parameters for the opportunities for increasing the slab spans, a *pre-study* was conducted. Examples of the result, see Figure 3.1, display that high levels of concrete compression strength, as compared to low, generally do not affect the possibilities for increasing the slab spans, *unless* the reinforcement amounts exceed the limits for balanced reinforcement. Balanced reinforcement is the amount of reinforcement when yield in reinforcement occurs at the same time as compression failure in the concrete. The levels for balanced reinforcement (reinforcement quality KS 500) are 1,89% for K30 and 4,55% for K80, which strongly exceeds normal amounts used in house building. The concrete compression strength does not influence the opportunities for increasing the slab spans when using within house building commonly used reinforcement amounts (approximately 0,1-0,3%). Further, for amounts of 0,5- 1,0%, the differences are significantly less than for other parameters like the concrete slab thickness.

However, the pre-study also indicates that deformations within the serviceability limit state strongly limit the slab spans with regard to the in practice often used maximally allowed deflection (as for instance span divided with 400,  $L/400$ ). The pre-study shows that the influence of concrete compression strength on the deformations is of minor importance, when comparing to other concrete parameters as the elastic modulus (creep ratio) and the tensile

strength. On the basis of the pre-study result, the levels of compression strength for the main structural design study are limited to K30 and K80. According to the Swedish building regulations, the K-value defines the minimum level allowed of concrete cube compression strength corresponding to the statistic level of the lowest 5%-fractile. Further, the *characteristic* compression strength defines the level that corresponds to 85% of the concrete cylinder compression strength. This leads to the characteristic levels of 21,5 and 56,5 MPa for K30 and K80 respectively.

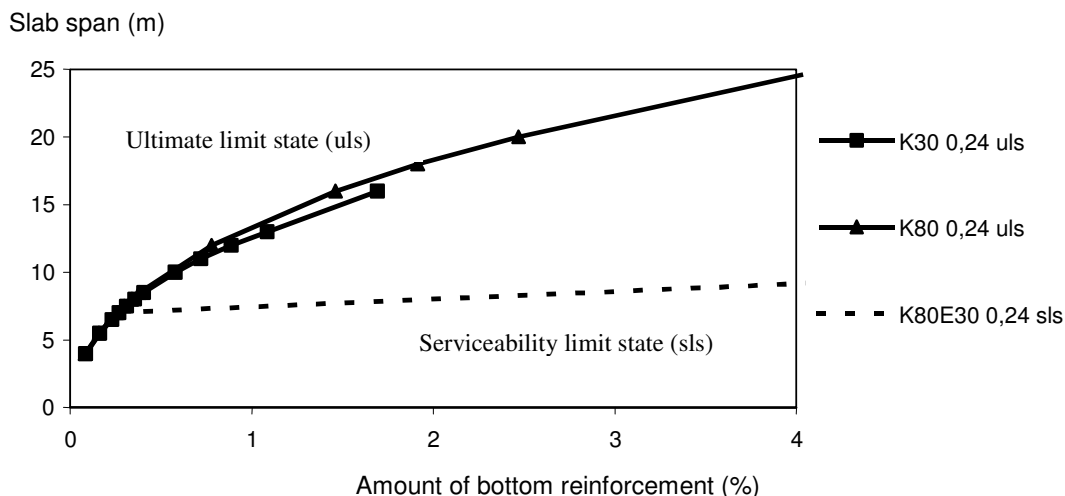

Figure 3.1: Result of the pre-study displaying the influence of concrete compression strength on the maximum slab span allowed for a one-way reinforced slab. Regard is taken to the ultimate limit state and the possible slab span within the serviceability limit state (maximum deflection allowed = span/400).

#### Concrete tensile strength, elastic modulus and creep ratio

For each K-value, the Swedish building regulations allow utilisation of specific characteristic levels of the tensile strength as well as the elastic modulus. Therefore the values of the characteristic concrete tensile strength used in the calculation are set to 1,6 and 2,5 MPa corresponding to K30 and K80 respectively. However, if special investigations verify higher levels, the Swedish norm allows exploitation of increased levels. Therefore, also the effects of characteristic tensile strength of 5,0 MPa are calculated. Though high, this value is assumed to be realistic for a well-designed HPC, see further Chapter 2.1.2. “HPC- some important properties compared to NPC”.

Further, the Swedish building regulations allow usage of characteristic E-modulus levels of 30 GPa for K30 and 38,5 GPa for K80. As in the case of the tensile strength, it is allowed to utilise higher values if investigations verify this. Therefore the effect is calculated for three levels of characteristic elastic modulus, 30, 40 and 50 GPa. These values are assumed to be realistic if high quality aggregate is used. By using different values of E-modulus, the creep ratio is considered. Therefore the creep ratio is set to 0. For some calculations however, the creep ratio is set to 2 in order to only display the effect of increased creep ratio, and not varying the elastic modulus. For potential exploitation of increased tensile strength and elastic modulus, see further Chapter 2.1.2.



### Summary of used concrete parameters

In Table 3.1, the concrete parameters used within the study are displayed. The characteristic values are further reduced to design levels using partial coefficients, see further section 3.3.3 “Material data” and Appendix A “Structural study – background information”.

Table 3.1: K-values, characteristic strength, elastic modulus and creep ratio of the concrete parameters used within the study.

| Concrete parameter                                     | Levels           | Unit |
|--|------------------|------|
| K-value (Swedish Building Standards)                   | 30 and 80        | -    |
| Characteristic concrete compression strength, $f_{ck}$ | 21,5 and 56,5    | MPa  |
| Characteristic concrete tensile strength, $f_{ctk}$    | 1,6, 2,5 and 5,0 | MPa  |
| Characteristic concrete elastic modulus, $E_{ctk}$     | 30, 40 and 50    | GPa  |
| Concrete creep ratio, $\phi$                           | 0 and 2          | -    |

### 3.2.2 Loads

Loads are set in accordance with the Swedish building norm, BKR99 Chapter 2:321 and 3:4 (Boverket, 1999), for multi-family residential buildings. The load values and partial coefficients, with regard to the ultimate and serviceability limit state for each load type, are shown in Table 3.2. For further details, see Appendix A.

Table 3.2: Characteristic load values used, together with partial coefficients ( $\gamma$ ) for both the ultimate and serviceability limit state and load reduction coefficients  $\psi$ .

| Load type            | Value                 | Partial coeff. $\gamma_f$ (ultim.) | Partial coeff. $\gamma_f$ (serv.) | Load red. coeff. $\psi$ |
|----------------------|-----------------------|------------------------------------|-----------------------------------|-------------------------|
| $G_k$ Dead load      | 2,4 kN/m <sup>2</sup> | 1,0                                | 1,0                               | -                       |
| $Q_k$ Variable bound | 0,5 kN/m <sup>2</sup> | 1,3                                | 1,0                               | 1,0                     |
| $Q_k$ Variable free  | 1,5 kN/m <sup>2</sup> | 1,3                                | 1,0                               | 0,33                    |

### 3.2.3 Deflection

The maximum deflection allowed is in the study set to  $L/400$ , where L is the slab span (in meters). As a comparison, the effects of the criterion  $L/300$  also have been estimated. See 3.5.3 Additional results.

### 3.2.4 Reinforcement

The reinforcement used in the study is ribbed bars of quality Ks 500, in accordance with the Swedish building norms. See Appendix A for further details.

### 3.2.5 Studied slab types – general properties

Six types of reinforced concrete slabs have been analysed. They represent the most frequently used structural frames in multi-dwelling buildings. Each slab type including characteristic basic data are presented below.

#### Slab type 1: One-way reinforced slab (slab/wall-structure)

##### Conditions

- Slab span,  $L$ , varies between 5,0 and 15 m
- Slab width is set to 1,0 m
- Slab thickness 0,20 and 0,24 m
  
- Wall thickness 0,3 m
- Wall height 3,0 m
  
- Hinged connections
- Uplift of slab end not allowed
- Safety class 2 (see Appendix A)

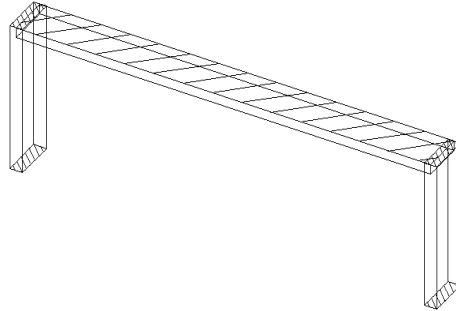

Figure 3.2 Slab type 1, one-way reinforced slab

#### Slab type 2: Single, two-way reinforced slab (slab/wall-structure)

##### Conditions

- Slab span,  $L$  varies between 5,0 and 15 m
- Slab thickness 0,20 and 0,24 m
  
- Wall thickness 0,3 m
- Wall height 3,0 m
  
- Hinged connections
- Uplift of slab end not allowed
- Safety class 2

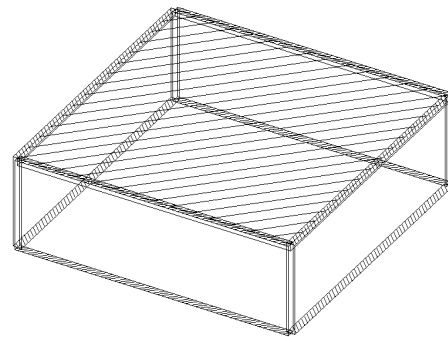
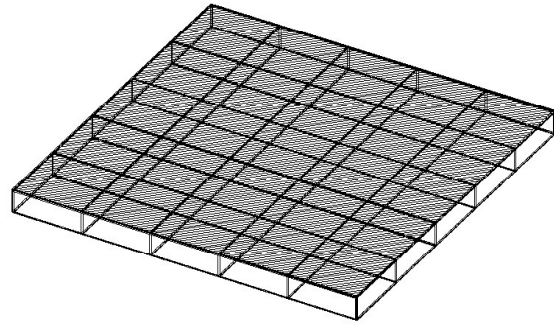

Figure 3.3 Slab type 2, single two-way reinforced slab.

### Slab type 3: Two-way reinforced inner field (slab/wall- structure)

#### Conditions

- Slab span,  $L$  varies between 5,0 m and 15 m
- Slab thickness 0,20 and 0,24 m
- Wall thickness 0,3 m
- Wall height 3,0 m
- Hinged connections
- Uplift of slab end not allowed
- Safety class 2

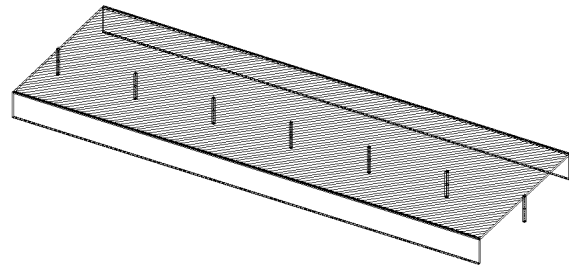

*Figure 3.4 Slab type 3, Two-way reinforced inner field.*

### Slab type 4: Indefinite long girderless floor (slab/column- structure) on facade walls

#### Conditions

- Slab span between columns,  $L$  varies between 5,0 and 15 m
- Slab thickness 0,20 and 0,24 m
- Column width 0,3 m
- Column height 3,0 m
- Hinged connections
- Uplift of slab end not allowed
- Safety class 2

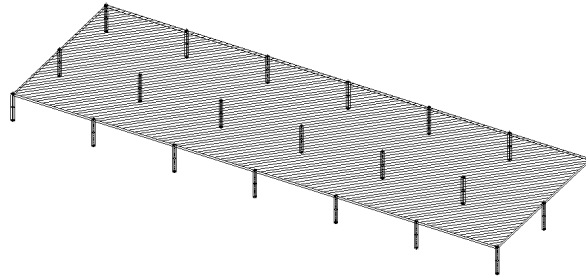

*Figure 3.5 Indefinite long girderless floor on facade walls.*

### Slab type 5: Indefinite long girderless floor (slab/column- structure) on facade columns

#### Conditions

- Slab span between columns, L varies between 5,0 and 15 m
- Slab thickness 0,20 and 0,24 m
- Column width 0,3 m
- Column height 3,0 m
- Hinged connections
- Uplift of slab end not allowed
- Safety class 2

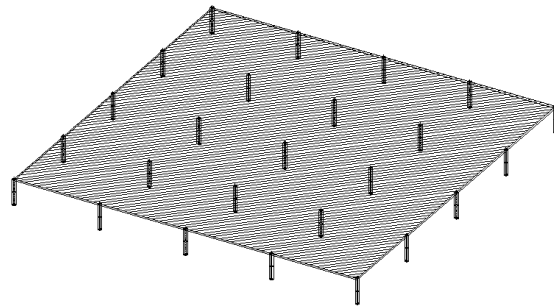

*Figure 3.6 Indefinite long girderless floor on facade columns*

### Slab type 6: Inner field of indefinite girderless floor (slab/column- structure)

#### Conditions

- Slab span between columns, L varies between 5,0 and 15 m
- Slab thickness varies between 0,20 and 0,24 m
- Column width 0,3 m
- Column height 3,0 m
- Hinged connections
- Uplift of slab end not allowed
- Safety class 2



*Figure 3.7 Slab type 6, Inner field of indefinite girderless floor.*

### **3.3 Structural calculations**

#### **3.3.1 Calculations performed**

For each of the 6 slab types described above, calculation of the ultimate and serviceability limit state was performed using the FEM-program FEM-Design Plate 3.50 (2000). The calculation was made according to the following steps.

##### **Step 1 Choice of slab**

- Type of slab
- Dimensions

##### **Step 2 Choice of material parameters**

- Concrete parameters
  - Compression strength
  - Tensile strength
  - Elastic modulus
  - Creep ratio
- Reinforcement parameters
  - Reinforcement quality (only one type used, KS 500)
  - Amount of reinforcement (to simulate effects within the serviceability limit state)

##### **Step 3 Consideration to cracking and load conditions**

- No regard to cracking of concrete in the ultimate limit state
- Regard to cracking of concrete in the serviceability limit state
- Regard to different load combinations

##### **Step 4 Results**

- Required bottom and top reinforcement amounts in x- and y-direction (ultimate limit state)
  - With regard to maximum moment
  - With regard to varying moments over the slab
- Punching effects if slab/column structure (ultimate limit state)
- Displacements (serviceability limit state)
  - Comparison between estimated and maximum allowed displacement

##### **Step 5 Repetition of calculation cycles**

- For each type of slab, the calculation cycles are repeated with other slab spans and materials parameters

##### **Step 6 Presentation of results**

- All results are exported to Excel sheets and presented both as tables and diagrams

### **3.3.2 Method of calculation – norms and equations (Swedish Building Code BBK94)**

For more detailed description of the method of calculation, see further Appendix A “Structural design study – background information”, where equations according to the following literature are presented:

- The Swedish Building Code BBK94 (Boverket, 1994)
- Handbook of Concrete-Design, “BHK” (Swedish Building Centre, 1990)

A brief description of the method of calculation is given below.

#### **Ultimate limit state**

##### *Main reinforcement*

Section forces and design moments in the slabs are calculated by elastic theory, according to the Swedish Building code BBK94 Chapter 6.5.3.2 and “BHK”, Chapter 3.2:125.

Required bending reinforcement is designed according to “BHK” 3.6:43, Figure 3.6:12b.

##### *Shear capacity*

Shear capacity of the concrete is calculated according to BBK94 3.7.3.2.

##### *Punching*

The slab capacity with regard to punching is calculated according to BBK94 6.5.4-5 and BHK 6.5:34.

#### **Serviceability limit state**

##### *Method of solution*

Calculations of deflections and cracks within the serviceability limit state are performed for all load combinations in accordance with BHK 4:5 and 4:6.

The decrease in slab stiffness due to cracking has been considered in the calculations. In the calculations, slabs are first assumed to be uncracked and cross-section forces are calculated. In the next step, the calculated moments are controlled and compared to the crack moments to estimate whether sections are belonging to “Stadium I” (uncracked condition) or “Stadium II” (cracked condition). Required bending reinforcement is calculated for each element as the maximum value for all load combinations.

### 3.3.3 Material data

According to BBK94 2.3, the characteristic values described within section 3.2.3 of this chapter have to be reduced to the design values as follows:

#### Ultimate limit state

Concrete compression strength,  $f_{cc}=f_{cck}/1,5\gamma_n$

Concrete tensile strength,  $f_{ct}=f_{ctk}/1,5\gamma_n$

Concrete elastic modulus,  $E_c=E_{ck}/1,2\gamma_n$

Steel tensile strength,  $f_{st}=f_{yk}/1,1\gamma_n$

Steel elastic modulus,  $E_s=E_{sk}/1,05\gamma_n$

The values of  $\gamma_n$  are, according to “BHK”, Table 2.3:2 (Swedish Building Centre, 1990), dependent on safety class, as follows:

$\gamma_n=1,0$  for safety class 1 (low)

$\gamma_n=1,1$  for safety class 2 (normal)

$\gamma_n=1,2$  for safety class 3 (high)

#### Serviceability limit state

Concrete tensile strength,  $f_{ct}=f_{ctk}/1,0$

Concrete elastic modulus,  $E_c=E_{ck}$

### 3.4 Result

#### 3.4.1 Comparison between NPC and HPC regarding maximum slab span

The study has resulted in a large number of diagrams that are presented in Appendix B, displaying the slab span as function of required amount of reinforcement. Regard has been taken to both ultimate and serviceability limit state and effects of concrete compression strength, tensile strength and elastic modulus. The effects of concrete slab thickness, creep ratio and alternative deformation criteria are also presented.

Table 3.3 below summarises the result of the design study by presenting the maximum span with regard to ultimate and serviceability limit state for HPC and NPC respectively. To clearly display the differences in effects of the studied concrete types, the chosen HPC represents the most optimised HPC, or in other words, both tensile strength and elastic modulus are increased although within a range, assumed to be realistic with regard to practical production. The result is based on calculations where slab thickness and maximum displacement allowed are set to 0,2 meter and L/400 respectively. The creep ratio is

constantly set to 0. In order to simulate creep effects, various levels of E-modulus are used in the calculations.

Concerning the reinforcement amounts presented, the required amount of bottom reinforcement is calculated for the *maximum* slab moment for one single axis (x). The *average required* bottom reinforcement is estimated as the mean value of the required reinforcement, with regard taken to the varying moments in the finite elements of the slab section. The required reinforcement is based on the ultimate limit state.

The most significant parameters when addressing the possibility for increasing the slab spans are the amount of reinforcement (ultimate limit state), slab thickness (ultimate and serviceability limit state), concrete tensile strength (ultimate and serviceability limit state) and concrete elastic modulus (serviceability limit state). For slab types 1, 2 and 3 (slab/wall structures), the most important factor that reduces the maximum slab span is the deflection criterion with regard to the serviceability limit state. High levels of concrete tensile strength and/or E-modulus, however, increase the maximum slab span allowed with regard to the serviceability limit state. For slab types 4, 5 and 6, (slab/column structures), the punching effect strongly reduces the maximum slab span with regard to the ultimate limit state. A large increase in slab span is however possible if an increased level of concrete tensile strength is utilised.

*Table 3.3 Comparison between HPC and NPC regarding the maximum span allowed for all studied slab types (1-6).*

| Slab type | Concrete type | Characteristic compression strength (MPa) | Characteristic tensile strength (MPa) | Characteristic E-modulus (GPa) | Maximum span ultimate limit state (m) | Maximum span serviceability limit state (m) | Maximum bottom reinforcement amount (%) | Mean reinforcement amount (%) |
|-----------|---------------|---|---------------------------------------|--------------------------------|---------------------------------------|---|---|-------------------------------|
| 1         | NPC           | 21,5                                      | 1,6                                   | 30                             |                                       | 6,0   | 0,259                                   | 0,171                         |
| 1         | HPC           | 56,5                                      | 5,0                                   | 50                             |                                       | 8,5   | 0,344                                   | 0,277                         |
| 2         | NPC           | 21,5                                      | 1,6                                   | 30                             |                                       | 9,5   | 0,229                                   | 0,174                         |
| 2         | HPC           | 56,5                                      | 5,0                                   | 50                             |                                       | 13,0  | 0,329                                   | 0,25                          |
| 3         | NPC           | 21,5                                      | 1,6                                   | 30                             |                                       | 14,0  | 0,245                                   | 0,074                         |
| 3         | HPC           | 56,5                                      | 5,0                                   | 50                             |                                       | 20,0  | 0,354                                   | 0,106                         |
| 4         | NPC           | 21,5                                      | 1,6                                   | 30                             | 6,0                                   |   | 0,137                                   | 0,025                         |
| 4         | HPC           | 56,5                                      | 5,0                                   | 50                             | 9,0                                   |   | 0,327                                   | 0,055                         |
| 5         | NPC           | 21,5                                      | 1,6                                   | 30                             | 5,0                                   |   | 0,121                                   | 0,035                         |
| 5         | HPC           | 56,5                                      | 5,0                                   | 50                             | 8,5                                   |   | 0,299                                   | 0,087                         |
| 6         | NPC           | 21,5                                      | 1,6                                   | 30                             | 5,0                                   |   | 0,06                                    | 0,02                          |
| 6         | HPC           | 56,5                                      | 5,0                                   | 50                             | 11,0                                  |   | 0,294                                   | 0,1                           |



Figure 3.8 presents the main result of Table 3.3 visualised in the form of a diagram.

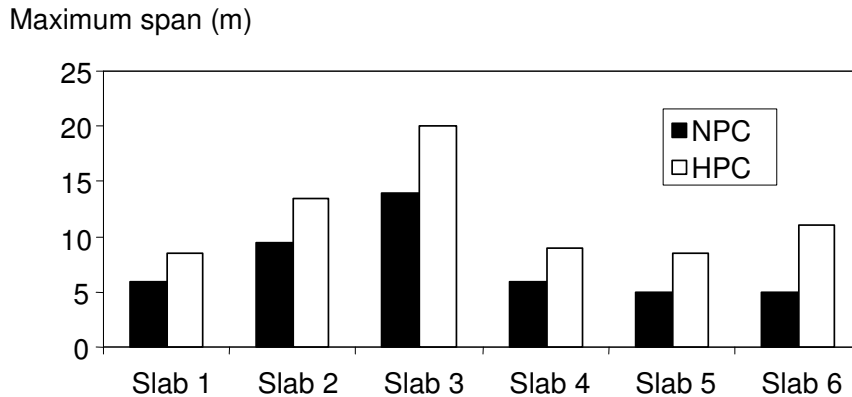

Figure 3.8. Comparison between normal house-building concrete (NPC) and high performance concrete (HPC) with regard to maximum slab span allowed in all studied slab types.

### 3.4.2 Effects of concrete properties on maximum slab span for slab/wall structures

The effects of the studied parameters on the maximum slab span for slab/wall structures for slab type 1 are shown in Figure 3.9. The parameters are explained in Table 2. For NPC, the maximum span for slab type 1 is limited to 6 metres, even when increasing the reinforcement. This limit is based on the fact that the maximum span is determined by deflection. An increase in the amount of reinforcement allows for larger slab spans, provided that the displacement criterion ( $L/400$ ) regarding the serviceability limit state is not exceeded. Concerning HPC though, both the maximum slab span and the reinforcement amount are possible to increase further, if increased values of concrete E-modulus and/or tensile strength are utilised.

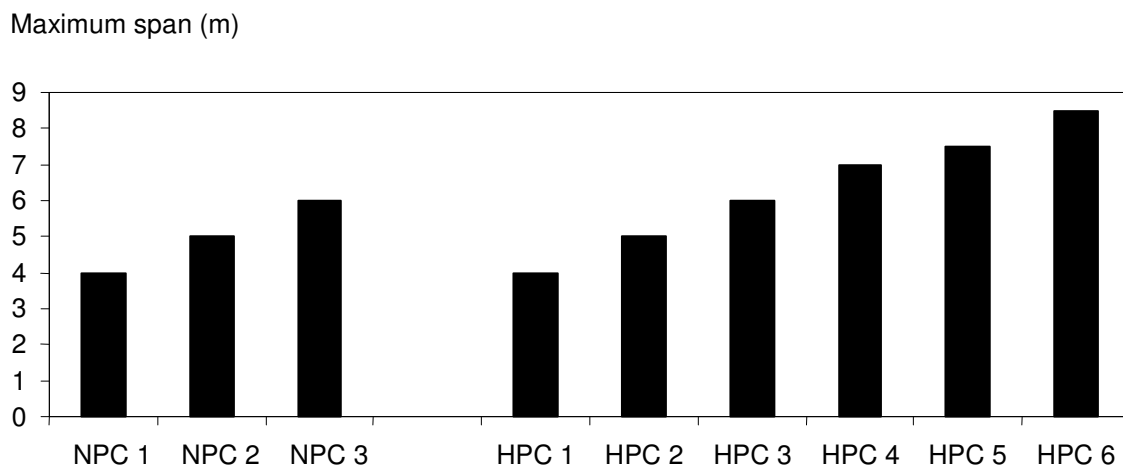

Figure 3.9 Effects of various concrete and slab parameters on maximum slab span. Slab type 1.

Table 3.4 Definition of the parameters used in Figure 3.9.

| Concrete type | Description  |
|---------------|--|
| NPC 1         | NC, reinforcement amount 0,1%, thickness 0,20 m                              |
| NPC 2         | NC, thickness 0,24 m   |
| NPC 3         | NC, reinforcement amount 0,25%, thickness 0,20 m                             |
| HPC 1         | HPC, reinforcement amount 0,1%, thickness 0,20 m                             |
| HPC 2         | HPC, thickness 0,24 m  |
| HPC 3         | HPC, reinforcement amount 0,25%, thickness 0,20 m                            |
| HPC 4         | HPC, E-modulus 50 GPa (reinforcement amount 0,34%)                           |
| HPC 5         | HPC, tensile strength 5,0 MPa (reinforcement amount 0,4%)                    |
| HPC 6         | HPC, tensile strength 5,0 MPa, E-modulus 50 GPa, (reinforcement amount 0,5%) |

### 3.4.3 Effects of concrete and slab parameters on maximum slab span for slab/column structures

Figure 3.10, which corresponds to Figure 3.9, presents slab/column structures (slab type 4). Here, *punching* with regard to the ultimate limit state is the most significant reduction effect on the maximum slab span. The result indicates that concrete tensile strength is the most important property for increasing the maximum slab span, when regard is taken to punching. A high value of concrete tensile strength and an increased slab thickness will permit the use of larger spans in the ultimate limit state. Increased tensile strength and/or increased E-modulus must be used in order to decrease deflections. The diagram displays large differences between NPC and HPC in their respective potential for utilisation of increased tensile strength and elastic modulus in order to increase the span.

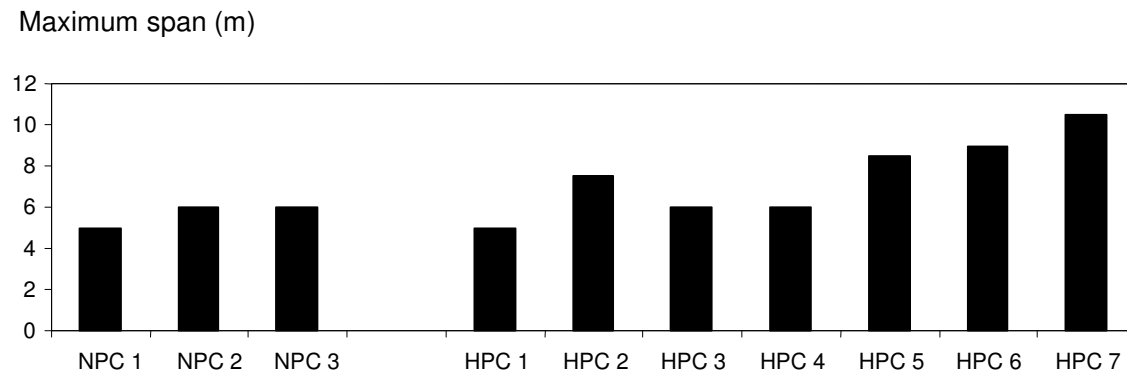

Figure 3.10 Effects of different concrete and slab parameters on maximum slab span for slab type 4.

Table 3.5 Explanation to parameters used in Figure 3.10.

| Concrete type | Description   |
|---------------|---|
| NPC 1         | NC reinforcement amount 0,09%, thickness 0,20 m   |
| NPC 2         | NC thickness 0,24 m   |
| NPC 3         | NC reinforcement amount 0,14%, thickness 0,20 m   |
| HPC 1         | HPC reinforcement amount 0,09%, thickness 0,20 m  |
| HPC 2         | HPC thickness 0,24 m  |
| HPC 3         | HPC reinforcement amount 0,14%, thickness 0,20 m  |
| HPC 4         | HPC E-modulus 50 GPa (reinforcement amount 0,14%)   |
| HPC 5         | HPC tensile strength 5,0 MPa (reinforcement amount 0,29%)                                     |
| HPC 6         | HPC tensile strength 5,0 MPa, E-modulus 50 GPa, (reinforcement amount 0,33%)                  |
| HPC 7         | HPC tensile strength 5,0 MPa, E-modulus 50 GPa, thickness 0,24 m (reinforcement amount 0,33%) |

### 3.4.4 Summary

For the studied slab/wall structures (slab types 1-3), the maximum allowed slab span is to a large extent dependent on the maximum deflection allowed. The presented result is based on displacement limits defined as  $L/400$ , where  $L$  is the slab span. The concrete parameters most influential on maximum slab span are tensile strength and E-modulus. High levels of these concrete properties and increased slab thickness also allow utilisation of high amount of reinforcement.

Concerning studied slab/column structures (slab types 4-6), the punching effect of the ultimate limit state considerably reduces the possibilities for larger spans. The most potential concrete property to optimise in order to reduce the punching effect is, according to the conducted calculations, the tensile strength. If this is set twice as high as the normally used level (5,0 MPa), opportunities are created for largely increased spans. However, to manage the displacement limit, it is also important to increase the E-modulus. The slab thickness affects the span in both ultimate and serviceability limit state.

Approximate effects of studied parameters on the maximum slab span are displayed in Table 3.6. See also Appendix B “Structural design study – results”.

Table 3.6 Summarised approximate quantification of the studied parameters' influence on the possibility for increasing the maximum slab span allowed when regard is taken both ultimate and serviceability limit state.

| Parameter   | Slab 1-3<br>(slab/wall structures) |                               | Slab 4-6<br>(slab/column structures) |                               |
|---|------------------------------------|-------------------------------|--------------------------------------|-------------------------------|
|   | Ultimate<br>limit state            | Serviceability<br>limit state | Ultimate<br>limit state              | Serviceability<br>limit state |
| Concrete slab thickness<br>(increase from 0,20 to 0,24 m)         | 25%                                | 15%                           | 20%                                  | 15%                           |
| Concrete compression strength<br>(increase from 21,5 to 56,5 MPa) | <5%                                | <5%                           | 0%                                   | <5%                           |
| Concrete tensile strength<br>(increase from 2,5 to 5,0 MPa)       | 0%                                 | 20%                           | 50%                                  | 20%                           |
| Concrete elastic modulus<br>(increase from 30 to 50 GPa)          | 0%                                 | 15%                           | 0%                                   | 15%                           |
| Amount of reinforcement<br>(increase from 0,1% to 0,2%)           | 35%                                | <8%                           | 20%                                  | <8%                           |

### **3.5 Additional discussion of result**

#### **3.5.1 Ultimate limit state**

##### **Amount of reinforcement versus concrete quality**

With regard taken to the ultimate limit state, the most significant parameter affecting maximum slab allowed span is the amount of reinforcement. For instance, if the amount of reinforcement in a slab of type 1 is increased from 0,1% to 0,35%, the theoretical maximum span is increased from 4 to 8 metres, with slab thickness constantly set to 0,24 m and concrete quality to K30. If even larger amount of 1,6% is used, which is just less than the amount of balanced reinforcement for K30 concrete, the maximum span in the ultimate limit state can be increased up to 16 m. If the amount of reinforcement ever is larger than the balanced, the reinforcement starts to yield before the concrete breaks in compression. Since higher concrete qualities increase the level for balanced reinforcement, the possibilities for constructing larger spans can only be increased when extremely large amounts of reinforcement is used, amounts which are above the level of balanced reinforcement. However, when normal amount of reinforcement is used, the concrete compression strength does not affect the opportunity for building larger spans if only the ultimate limit state is considered.

##### **Required reinforcement due to maximum moment versus average moments**

The calculations for estimating the required reinforcement are based on the maximum moment of the slabs. Further, in practise, the most used method for ordinary one-way reinforced slabs (type 1) is to design all reinforcement with regard to the maximum moment, which can be described as an easy design and production method in practice but not as an optimal method, considering the materials costs of reinforcement.

However, the total amount of reinforcement required, based on the maximum moment, is significantly larger than the theoretical amount, based on the varying moment in the slab. With the aim of estimating the differences in required amounts of reinforcement, the mean reinforcement amount has also been calculated. These calculations are based on the theoretically required reinforcement in every FEM-node. When summarising and dividing with the number of nodes within the slab, a mean value is calculated. The difference between the mean and maximum value is in some cases large. For instance, theoretically, the reinforcement can be reduced by approximately 30% for one-way reinforced slabs like type 1. However, to further utilise this benefit in reality, CAD/CAM- produced reinforcement nets are required. See further 3.5.3 “Additional results” and 3.5.4 “Concluding remarks – additional results”.

##### **Punching**

For the slab/column structures (slab type 4 to 6), the dominating limitation for increase of slab spans is punching. The calculations show that when ordinary concrete is used, the maximum span is heavily reduced due to punching, even if reinforcement or the slab thickness is increased. The calculations further show that the concrete tensile strength significantly reduces the risk of punching. For many of the calculated slab types, the maximum span might be increased by approximately 50% when the characteristic concrete tensile strength is increased to 5 MPa.

## Examples of diagrams of calculation result

Appendix B contains all results from the calculations in the form of diagrams for each type of slab, for both the ultimate and serviceability limit state. Explanations to the diagrams regarding the ultimate limit state are presented in the following figures (3.11-3.13), where the different curves show the possible slab spans as function of the amounts of reinforcement regarding the *ultimate limit state*. Each curve represents a specific concrete quality (K-value) and slab thickness. The first diagram (Figure 3.11) represents slab type 1 and the two next following figures represent slab type 4 (slab/column structure). When comparing the two latter with each other, the effect of punching clearly shows that possible spans are heavily reduced when standard values of tensile strength are used. The grey curves show the possible span in the serviceability limit state.

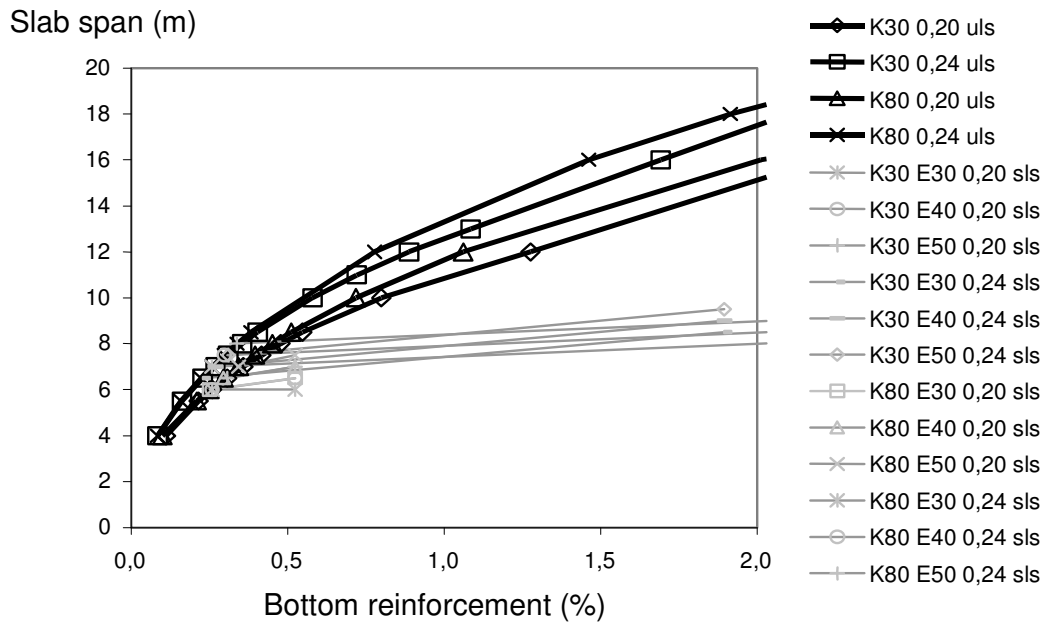

Figure 3.11 Example of diagrams for slab type 1. The bold curves indicate the maximum slab span regarding the ultimate limit state (uls). Reinforcement is calculated on basis of the maximum moment.

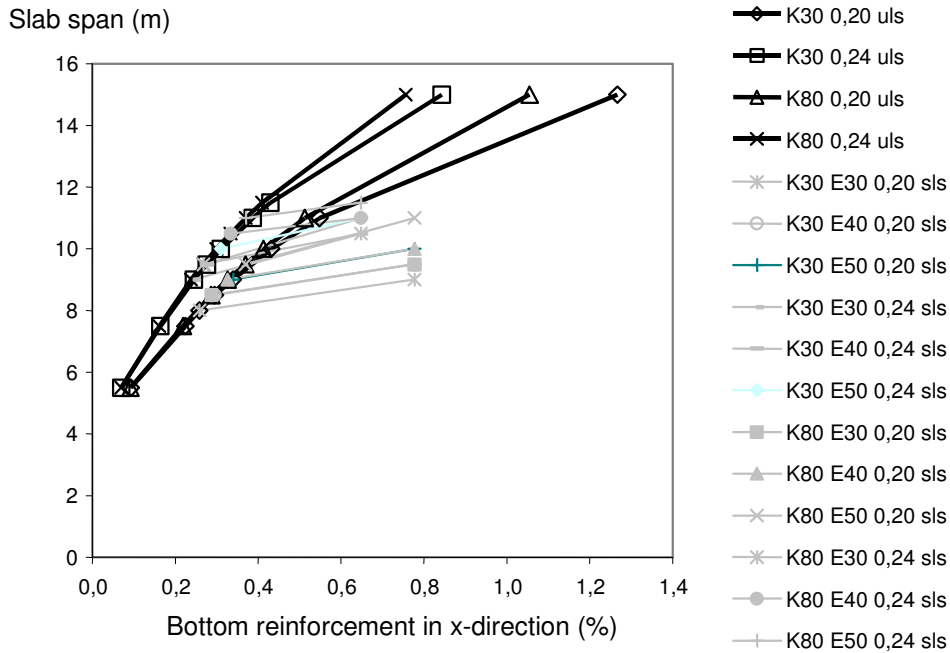

Figure 3.12 Example of diagrams for slab type 4 (slab/column structure), where the bold curves indicate the maximum slab span regarding the ultimate limit state (uls) but not including the punching effects. Reinforcement is calculated on basis of the maximum moment.

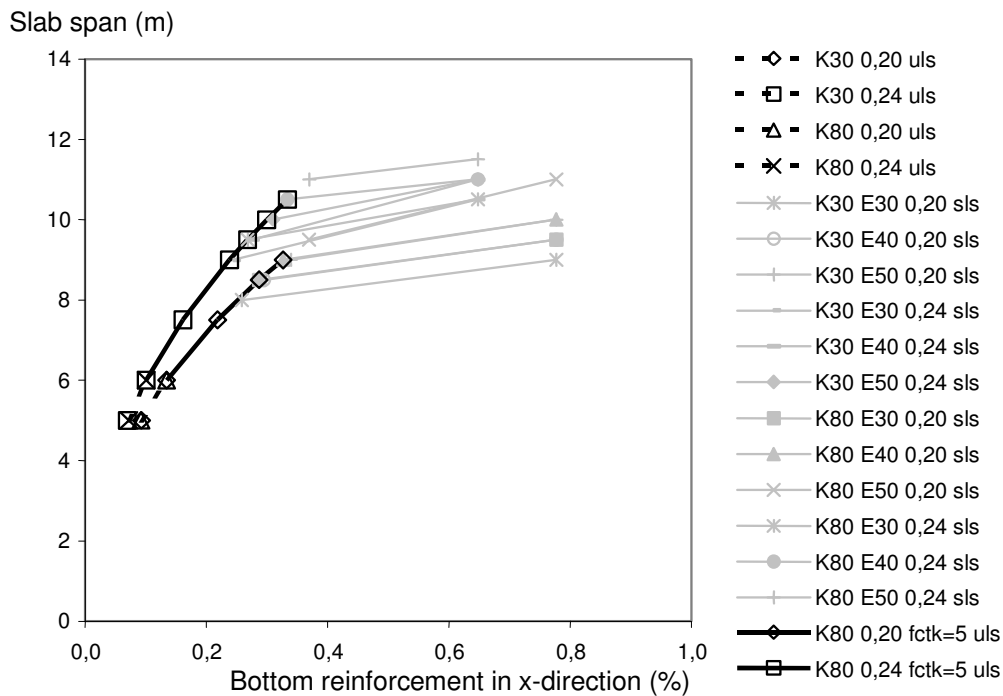

Figure 3.13 Example of diagrams concerning slab type 4 (slab/column structure), where the bold curves indicate the maximum slab span regarding the ultimate limit state (uls) and including the punching effects. Reinforcement is calculated on basis of the maximum moment.

## Summary of significant parameters in the ultimate limit state

In the ultimate limit state, the most significant parameters determining the opportunity for increasing the slab span are the amount of reinforcement and slab thickness. Concerning the concrete properties, the tensile strength is the most important parameter for increased slab span in such slab/column structures for which punching is the determining factor. The compression strength has marginal effect. The elastic modulus though, only affects the maximum slab span considering to deformations in the serviceability limit state (see next section).

### 3.5.2 Serviceability limit state

#### Amounts of reinforcement

The amount of reinforcement does not affect the possibilities for increased slab spans in the serviceability limit state, as much as in the ultimate limit state. To some extent though, a higher grade of slab stiffness is created if the amount of reinforcement is hugely increased. This gives a certain possibility for larger spans.

#### Example diagrams

In Figure 3.14 below, the bold curves display possible spans as function of the amount of reinforcement for the *serviceability limit state*. Each curve represents a specific concrete quality (K-value), E-modulus and slab thickness. The maximum deflection allowed, is limited to the slab span divided by 400 ( $L/400$ ). The grey curves show the possible span in the ultimate limit state. All result diagrams for each type of slab considering both ultimate and serviceability limit state are further presented in Appendix B.

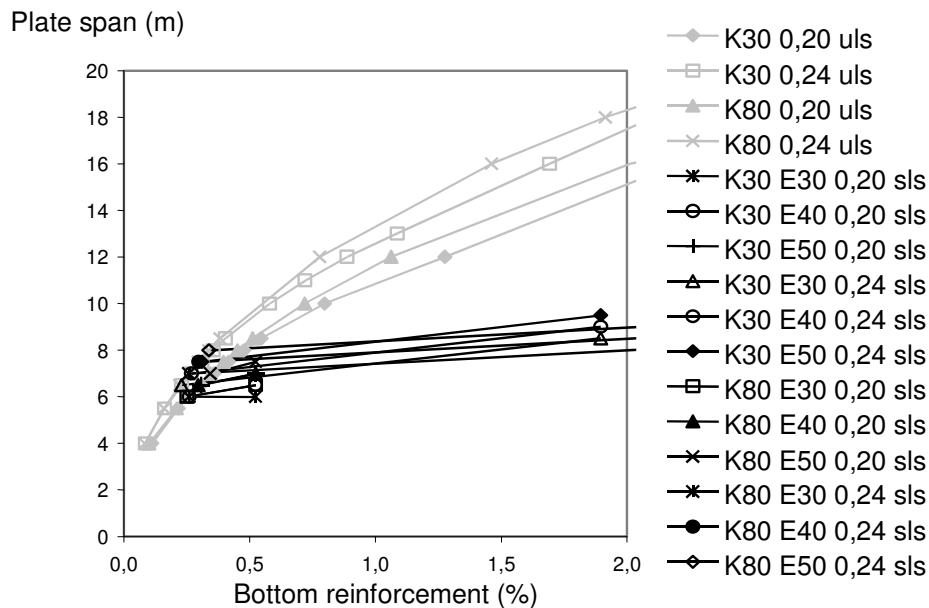

Figure 3.14 Example of result diagram concerning slab type 1, where the bold curves indicate the maximum slab span with regard to the serviceability limit state (sls). Maximum deflection allowed is  $L/400$ . Reinforcement is calculated on basis of the maximum moment.

### Summary of significant parameters in the serviceability limit state

The most significant parameters concerning increased slab span, with regard to deformation of the slab within the serviceability limit state, are the E-modulus, the slab thickness, and the concrete tensile strength. Besides, the criterion for maximum displacement has great importance.

### 3.5.3 Additional results

#### Required reinforcement based on the average moment in the slab

As shown in Figure 3.16, there is a significant difference between the required amount of reinforcement based on the maximum moment and the mean required amount of reinforcement based on the average moment for the slab. For instance, the reduction of reinforcement concerning slab 3 is approximately 70%. This indicates the potential of a more rational method for utilisation of reinforcement, where the reinforcement is based on the real moment curve and not only dimensioned with regard to the maximum moment in the slabs.

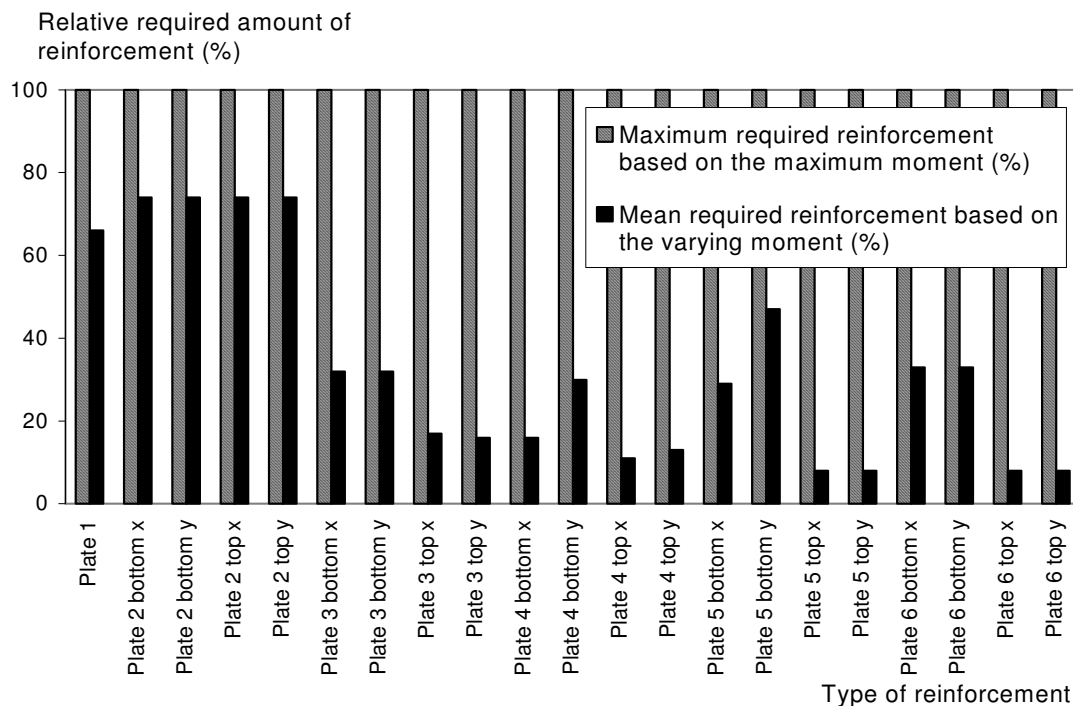

Figure 3.16 Comparison between required reinforcement based on the maximum and the average slab moment.

#### Effects of creep ratio and deflection requirements on the maximum allowed slab span

Figure 3.17 illustrates the effect of an increase in the creep ratio from 0 to 2 on the deflections. The maximum slab span is reduced by approximately 15%. However, instead of varying the creep ratio in the FEM-calculations, the E-modulus has been varied and the creep ratio constantly been set to 0.



The diagram also shows the effects of an alternative maximum deflection limit allowed. When reducing this from L/400 to L/300 (L= slab span), the maximum allowed slab span is increased by approximately 15%.

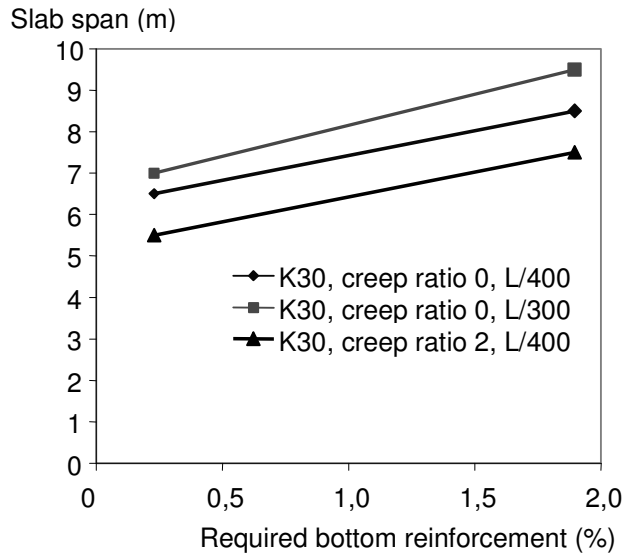

Figure 3.17 Estimated influence of increased concrete creep ratio (from 0 to 2) and decrease of the deformation criteria (from L/400 to L/300) on the maximum slab span allowed for slab type 1. Concrete quality K30.

### Effects of the concrete tensile strength on the deflections within the serviceability limit state

According to Figure 3.18 below, the maximum span with regard to deflections increases by 20% when increasing the characteristic concrete tensile strength,  $f_{ctk}$ , from 2,5 MPa (which corresponds to K80 according to the Swedish building norm) to 5,0 MPa. The figure also displays the effect of increased amount of reinforcement on slab stiffness. However, as already mentioned, extremely large amount of reinforcement is required to increase the slab stiffness by the reinforcement itself.

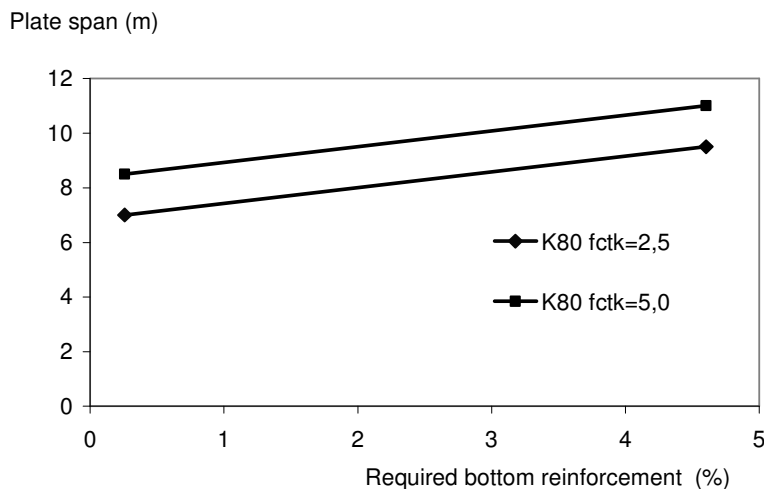

Figure 3.18 Estimated influence of increased concrete tensile strength (from 2,5 to 5,0 MPa) on the maximum slab span allowed for slab type 1 considering the serviceability limit state.

### 3.5.4 Concluding remarks

Increased concrete quality is traditionally characterised as concrete with increased compression strength, but as shown in this study, increased compressive strength is not a potential for increased slab spans. It is necessary to utilise other properties of HPC, e.g. high tensile strength and high elastic modulus.

#### Main results

##### *Effects of concrete properties on maximum slab spans allowed regarding to the ultimate limit state*

When summarising the effects of parameters concerning the potential for increased slab spans in structural frames, there are various aspects to take into regard. For slab/wall structures (slab type 1-3) without columns, where punching is not relevant, the significant parameters for increase of spans are mainly amount of reinforcement and slab thickness. If there is no punching effect, the concrete quality does not affect the potential for increased spans when regard is only taken to the ultimate limit state, and unless extremely high amount of reinforcement (above balanced reinforcement) is used. For slab/column structures though, the concrete tensile strength is a significant parameter for the increase of slab spans, since increased tensile strength increases the punching capacity. When summarising the effects of HPC on the maximum slab span regarding the ultimate limit state, it creates possibilities for increased spans only for slabs supported by columns.

##### *Effects of concrete properties on maximum slab spans regarding the serviceability limit state*

Concerning the *serviceability limit state* though, the concrete properties affect the possibilities for increasing the slab spans to larger extent than is the case with the ultimate limit state. If HPC with increased levels of elastic modulus and/or tensile strength is utilised, the maximum span for all studied slabs (slab type 1-6) may be significantly increased. Other parameters affecting deflections are slab thickness and to some extent the amount of reinforcement.

#### Additional results

##### *Effect of the creep ratio on deflections*

The main result of the study is based on calculations where the creep ratio has been set to 0, while three levels of the elastic modulus (30, 40 and 50 GPa) have been used. In paragraph 3.5.3 some results of the calculation of the effects of the creep ratio are briefly presented. When increasing the creep ratio from 0 to 2, the maximum slab span regarding the serviceability limit state is reduced by approximately 15%.

##### *Effects of the concrete tensile strength on deflections*

The study is mainly based on a tensile strength of concrete in accordance with the Swedish building regulations. It is 2,65 MPa for concrete with a quality of K80, except from the slab/column structures (slab type 4-6) where also tensile strength of 5 MPa is used in order to cope with punching. An increased level of tensile strength will result in increased stiffness due to increased cracking load. The result shows a significant potential for increasing the maximum slab span with regard to deflections, e.g. 20% for slab type 1 when the tensile strength is increased to 5 MPa. This level is not unrealistically high for HPC but requires

high-quality ingredients and proportion. In reality, another problem is the limitations within the building codes. For utilising higher values than 2,65 MPa, the Swedish codes state that special investigations are required. See further Chapter 6.1.1 “Technical obstacles for the implementation of HPC”.

#### *Effects of various regulations of the maximum allowed deflection*

The Swedish building regulations do not stipulate any maximum levels regarding the allowed deflection for concrete slabs in house-buildings. The value is dependent on the requirements valid for the specific building project. However, the general deformation criterion in practise is often a maximum deflection, equal to slab span divided with 400 ( $L/400$ ). To estimate the effects of alternative deflection criteria,  $L/300$  has been studied. It was shown that the maximum allowed slab span regarding deflections could be increased by 15% for slab type 1.

#### *Potential for utilisation of rational reinforcement*

The structural design study points out the possibility of using significantly decreased amount of total reinforcement if it is designed with regard to the real varying moment of the slab and not to the maximum moment. The difference between maximum and average amounts is large for all types of studied slabs. For some slabs the difference is 70%, which may lead to significant cost savings. Today the usage of reinforcement is often based on the maximum moment. If methods based on the average amount are practiced, as for instance through utilisation of CAD/CAM-methods, opportunities for large cost savings may be created. Another way of rationalising the usage of reinforcement is to combine nets designed for either maximum or average moment. Further, rational reinforcement methods already exist on the market place today, as for instance the BAMTEC-method (see Figure 3.19), which consists of prefabricated reinforcement nets, able to be rolled on the concrete slabs by only two persons (Fundia, 2002).



Figure 3.19 The BAMTEC-system is an example of competitive reinforcement solution (Fundia, 2002).

## **Utilisation of the result**

The study indicates a number of structural design benefits by utilisation of HPC for building structural frames in low- medium rise house-buildings. Economic effects are not analysed but the result can be used for an economical analysis, in which higher material cost of HPC can be compared with cost savings during production and economical benefit of a more flexible building. *Direct* economical benefits, according to the result are the presumptive reduction of concrete and/or reinforcement amounts by utilisation of HPC. There are also presumptive *secondary* economical benefits, as for instance reduced production costs by rapid production cycles through HPC (see Chapter 4.1 “Utilisation of HPC for increased productivity”) and further future cost savings with regard to the function of the building (e.g. flexibility, see further Chapter 5, “Building function related potential of new concrete materials”).

However, there are also technical, economical and building process related obstacles for the implementation of HPC. These obstacles are not discussed within this chapter but further described in Chapter 6, “Obstacles for the implementation of new concrete materials technology”.

## Chapter 4

### Production related potential of new concrete materials technology

#### 4.1 Utilisation of HPC for increased productivity

The study aims at estimating the potential of HPC in house building with regard to production related aspects. The main potential benefit is the possibility for *reducing the production time* either by decreasing the concrete drying time or by utilising the rapid strength development. The study consists of two separate studies where drying times and strength development are estimated with regard to various kinds of concrete qualities. Used tools are the PC-programs TorkaS 1.0 (1998) and Hett97 (1997) that simulate the concrete drying process and concrete strength development respectively. For both drying time and strength development, the surrounding conditions affect the result to large extent. With the aim of simulating realistic conditions on building sites, regard has been taken to various weather conditions, e.g. cold temperature and rain, as well as practical production methods, e.g. insulating, covering, and heating of concrete.

##### 4.1.1 Utilisation of HPC for reduced drying time

###### 4.1.1.1 Introduction

###### Background

A frequently discussed problem with cast in-situ concrete frames is the long drying times needed to avoid future moisture problems caused by floor covering applied on concrete slabs before a satisfying level of the concrete humidity was reached. These problems are related to ordinary house-building concrete used in production. RH 85 or 90% is often required according to the Swedish building norms. For a concrete quality of K30 (required compression strength level of 30 MPa), the required drying time can be as long as one or two years if the concrete is not protected from rain and/or cool surrounding temperatures and if a permanent formwork system as for example steel is used. This type of formwork leads to slow drying in only one direction. In many cases special methods or materials applied on the concrete must be utilised in order to keep the production time within acceptable limits and/or avoiding potential future moisture problems. If HPC with a low water/cement ratio is utilised, many of the described problems may be avoided. There are a number of field studies that indicate the efficiency of HPC for rapid drying during various climate conditions. For example, Persson (1999) has conducted field studies where the moisture levels in concrete slabs (of both NPC and HPC) have been measured.

###### Aim of the study

There are various parameters affecting the concrete drying time. The study aims at estimating the potential for reduction of drying time by taking primarily regard to concrete properties but also to parameters concerning surrounding conditions.

## Method of the study

Calculations of drying times in concrete slabs have been carried out by using the PC-program TorkaS 1.0 (1998). The PC-program is based on a theoretical analysis of moisture transport in concrete and is calibrated against laboratory studies conducted on RH-measurement of large amounts of concrete specimens for various concrete qualities. TorkaS 1.0 simulates the concrete drying process by using the time development of degree of hydration. This is based on measurements of chemically bound water at varying levels of temperature and relative humidity in the surrounding air.

The parameters in Table 4.1 were used in the calculations of drying.

*Table 4.1 Parameters included within the production study of concrete drying.*

| <b>Parameters</b>                  | <b>Levels</b>  |
|------------------------------------|--|
| Water/cement ratio                 | 0,65, 0,50, 0,40 and 0,35  |
| Cement content                     | 300, 400, 450 and 500 kg/m <sup>3</sup>  |
| Silica fume content                | 0 and 5%   |
| Slab thickness                     | 0,15, 0,20, 0,25 and 0,30 m  |
| Type of form                       | Filigran and steel   |
| Air temperature and rain frequency | Average weather data from SMHI (The Swedish Metrology and Hydrology Institute) valid for Bromma airport, Stockholm |
| Casting weather conditions         | Summer and winter  |
| Covering (protected from rain)     | Directly after casting and after 10 days   |
| Controlled drying climate          | Directly after casting and after 1 month   |
| Winter concrete temperature data   | Default and calculated by the PC-program Hett97  |

As shown in Table 4.2, the calculations of the study have been conducted for five different types of surrounding climate conditions, of which the first corresponds to controlled drying from casting (season independent), the second to summer conditions where controlled drying starts a month after casting and the last three to winter conditions. Concerning the first three simulated climate conditions, the default weather data within the PC-program are used directly, which means that the outdoor air temperature is used as concrete temperature data. This leads to an underrating of the concrete hydration during wintertime, since the concrete temperature is significantly higher than the air temperature during the first days after casting. The fourth and fifth climate conditions aim at simulating the effects of utilising the early heat development of concrete. Therefore, in Climate 4, the surrounding air temperature during the first 10 days after casting is 10°C, which within the PC-program simulates a concrete temperature of the same value. For the fifth climate condition, concrete heat development data calculated by the PC-program Hett97 (1997) have been utilised. This program calculates the heat and strength development of concrete constructions with regard taken to multiple surrounding factors, as for instance air temperature, formwork system and winter concrete protection methods, e.g. covering, insulation and heating of concrete. The fifth climate condition is assumed to be the most correct concerning hydration of concrete in winter climate, due to the fact that it uses the real hydration when winter concrete methods are used. Below, the differences between the simulated climate conditions are briefly displayed. Detailed descriptions for each climate condition are presented in the further sections. Concerning the result of the influence of climates on drying, some selected diagrams are presented within each climate section. See further Appendix C for all result diagrams concerning the effects of climate condition on concrete drying times.

Table 4.2 Brief description of the five studied climates.

| Climate | Casting date | Covering   | Controlled drying | Season | Notes                              |
|---------|--------------|------------|-------------------|--------|------------------------------------|
| 1       | 1 July       | 1 July     | 1 July            | -      | Controlled drying directly         |
| 2       | 1 July       | 11 July    | 1 August          | Summer |                                    |
| 3       | 1 January    | 11 January | 1 February        | Winter | Default temp data                  |
| 4       | 1 January    | 11 January | 1 February        | Winter | Temp 10°C first 10 days            |
| 5       | 1 January    | 11 January | 1 February        | Winter | Temp data from Hett97 first 4 days |

Calculations have been made for two levels of relative humidity on the “equivalent depth” in the concrete slab, 85% and 90%. “Equivalent depth” is defined as the depth from the concrete top surface, on which the relative humidity during drying equals the final relative humidity that is reached under a 100% impermeable flooring material put on top of the slab. For a slab drying in two directions, the “equivalent depth” is about 20% of the slab thickness. For one-sided drying it is about 40%.

#### 4.1.1.2 Calculation for Climate 1

##### – estimation of drying time with regard to controlled drying environment directly from start of concrete casting

#### Introduction

The first simulated climate condition simulates a surrounding environment where the construction directly from the start of casting is protected against rain, and where both the relative humidity in the air and the air temperature are controlled and constantly set to 60% and 18 °C respectively. This simulates concreting under indoor conditions such as within a sheltering tent. The use of weather protecting methods in the form of heated tents is increasing within house building in Sweden, see Figure 4.1, which exemplifies a weather protection tent by Jonsereids (2002). This method does not only protect the building materials from rain and speed up the drying of concrete through dryer and warmer drying climate, it also creates an advantageous work-environment, especially during the winter season.



Figure 4.1 Commonly utilised type of weather protecting tent (Jonsereids, 2002).

The aim of the calculations on Climate 1 is to estimate the difference in required drying time between different concrete qualities for a climate condition where controlled drying is used after one month after casting by utilising the built structural frame as the main weather protection, which often is common practise. As with the other simulated climates, the effects on required concrete drying time for reaching relative humidity of 85 and 90% respectively, with regard to variables as slab thickness, silica content and form type, are studied and presented in the separate diagrams.

## Conditions

In Figure 4.2 the simulated climate conditions during the first 40 days after concrete casting are presented. Also during the remaining time of the simulation, the surrounding climate is constantly set to 18°C surrounding air temperature and 60% relative humidity of the surrounding air.

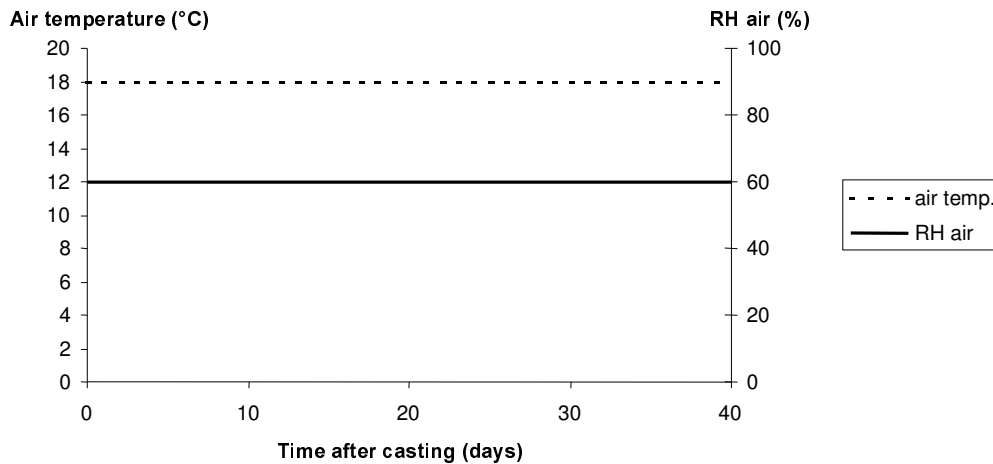

Figure 4.2 Surrounding climate conditions for Climate 1 during the first 40 days after concrete casting.

## Results

Five types of results are presented. See the figures 4.3 to 4.7, displaying the difference in required drying time with regard to:

- Water/cement ratio
- Type of formwork
- Slab thickness
- Silica fume content



**Drying time (months)**

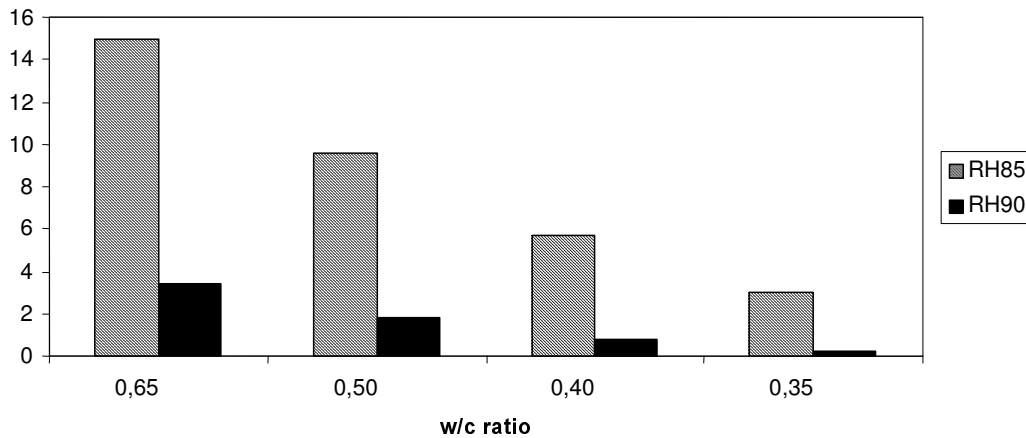

Figure 4.3 Calculated effect of the w/c ratio on the concrete drying time in Climate 1 for reaching a relative humidity of 85% or 90% on the equivalent depth. Filigran as formwork and 20 cm slab thickness exclusive formwork are constantly used within the calculations.

Figure 4.3 indicates that the drying time significantly decreases for concrete with reduced w/c ratio. The calculations are made for the same type of formwork (permanent concrete elements, Filigran), as well as for the same slab thickness (0,20 m). None of these calculations includes silica fume in the concrete.

**Drying time (months)**

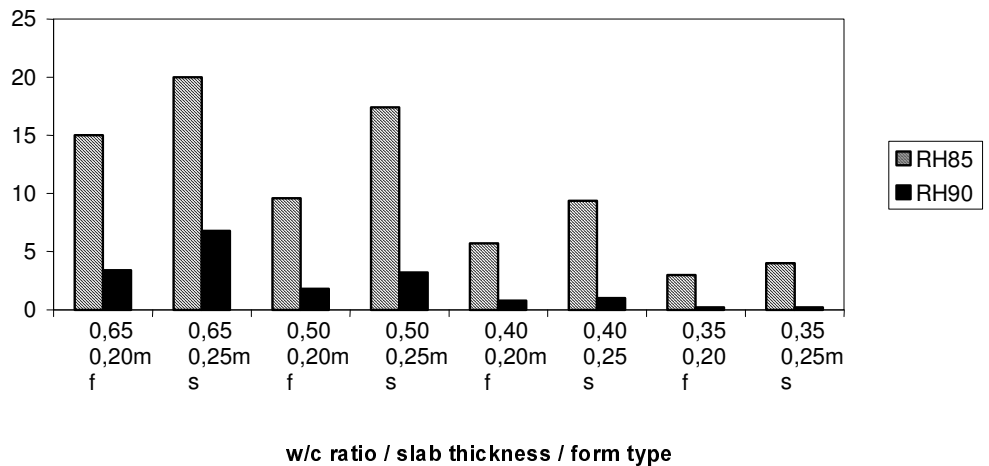
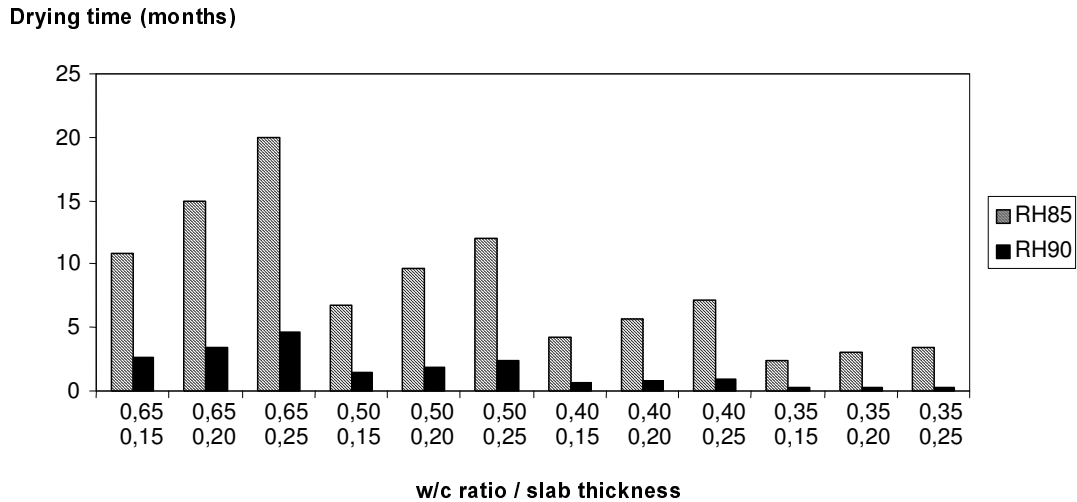

Figure 4.4 Calculated effect of the type of formwork on the concrete drying time for different concrete qualities (w/c ratios) for reaching 85% or 90% relative humidity on the equivalent depth. The letter “f” indicates that permanent concrete elements, so called “Filigran” are used as formwork and “s” that permanent formwork of steel is used. Concerning the result of the Figure, all calculations are based on no utilisation of silica fume. The total concrete slab thickness including formwork is constantly set to 0,25 (Filigran-formwork has a thickness of 5 cm).

With regard to formwork system (precast permanent concrete formwork element, so called “Filigran” and permanent formwork of steel), the required drying time differs for various w/c ratios as shown in Figure 4.4. The total concrete slab thickness is for both types of formwork

systems constantly set to 0,25 meter. A 0,20 m concrete slab on “Filigran” formwork corresponds to a 0,25 m concrete slab on steel formwork regarding total concrete thickness, due to the fact that the thickness of Filigran-form is 0,05 m. The main reasons to the displayed differences in required drying time for the two formwork systems the difference in the cast concrete thickness and the fact that a “Filigran” formwork allows drying in two directions (compared to steel formwork that only allows single direction drying).



*Figure 4.5 Estimated effects of the slab thickness on the required drying time for reaching 85 and 90% RH on the equivalent depth. For the calculations, permanent concrete formwork “Filigran” is used. No silica fume is used.*

As shown in Figure 4.5, the concrete slab thickness has a strong effect on the drying time. An increase in slab thickness leads to an increase in required drying time. For concrete with low w/c ratios, the self-desiccation effect makes the difference in drying time caused by slab thickness smaller. The self-desiccation in low w/c-concrete occurs homogenously over the entire concrete thickness. For high w/c ratio, drying is almost entirely caused by physical drying through moisture transport to the surroundings. In this case the effect of slab thickness is strong.

### Drying time (months)

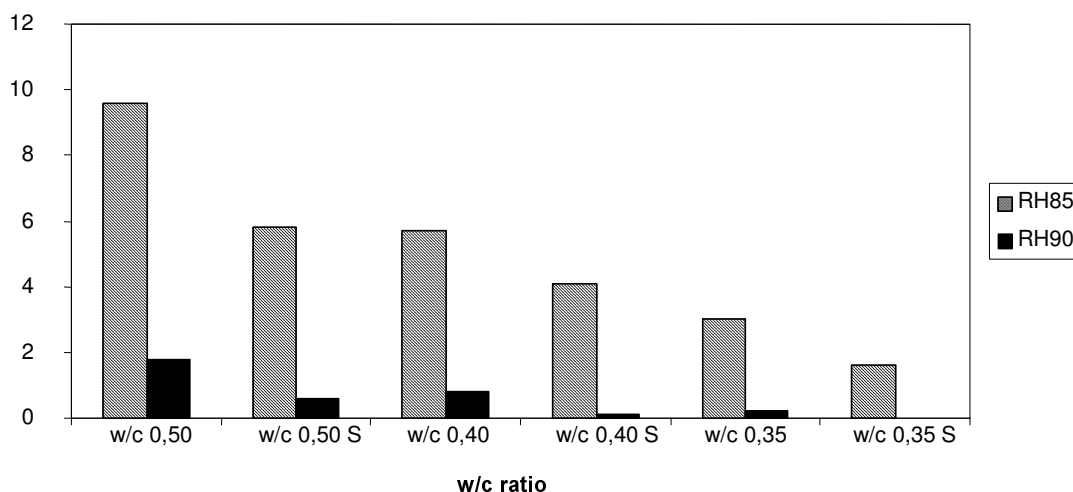

Figure 4.6 Estimated effects of silica fume content (marked as “S”) on the concrete drying time. Calculations are based on constant use of permanent concrete elements, “Filigran” as formwork and a cast concrete slab thickness is of 0,20 m.

In Figure 4.6, the letter “S” indicates that a silica fume content of 5% is included. For each w/c ratio, drying times for concrete with and without silica fume are presented. For reaching the RH level of 85%, concrete including silica fume needs approximately about 2/3 of the required drying time of concrete including no silica fume.

#### 4.1.1.3 Calculation for Climate 2

##### – estimation of drying time with regard to controlled drying 1 month after start of concrete casting (summer conditions)

#### Introduction

When a weather-protecting tent is not used, a common and traditional alternative is to use the concrete structural frame as a tool both for protection against rain (when next floor above the actual is built) and for controlled drying climate, provided that openings for windows, doors, etc. are covered and heating systems are utilised for getting an effective drying climate. The advantage of this method is that it is not as expensive as an external tent. However, there are risks for extended drying times if the coverings are not properly done and/or long time is required for next floor production. This production method is called Climate 2.

#### Conditions

In comparison to the calculations on Climate 1 where controlled drying is applied directly from the start of casting, Climate 2 simulates surrounding conditions where controlled drying starts one month after the casting during summertime. During the first 10 days the concrete construction is simulated as unprotected, which, based on statistical weather included within TorkaS 1.0, leads to 1 day of rain.

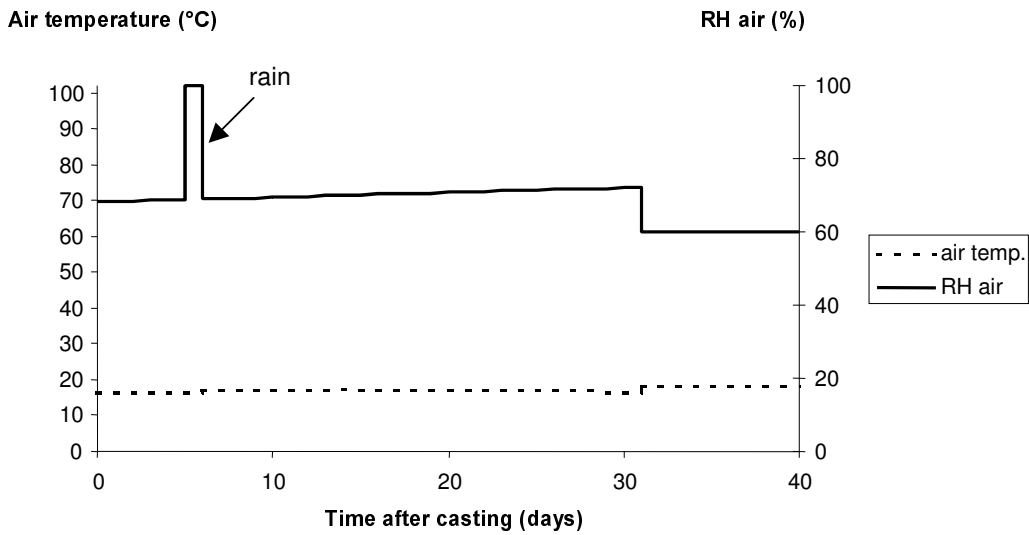

Figure 4.7 Surrounding climate conditions for Climate 2 during the first 40 days after concrete casting.

## Results

See Appendix C for all result diagrams concerning Climate 2, displaying effects of formwork type, concrete slab thickness and silica fume content on the required drying time for reaching RH levels of 85% and 90%. A diagram showing the effect of w/c ratio on the drying time is presented below.

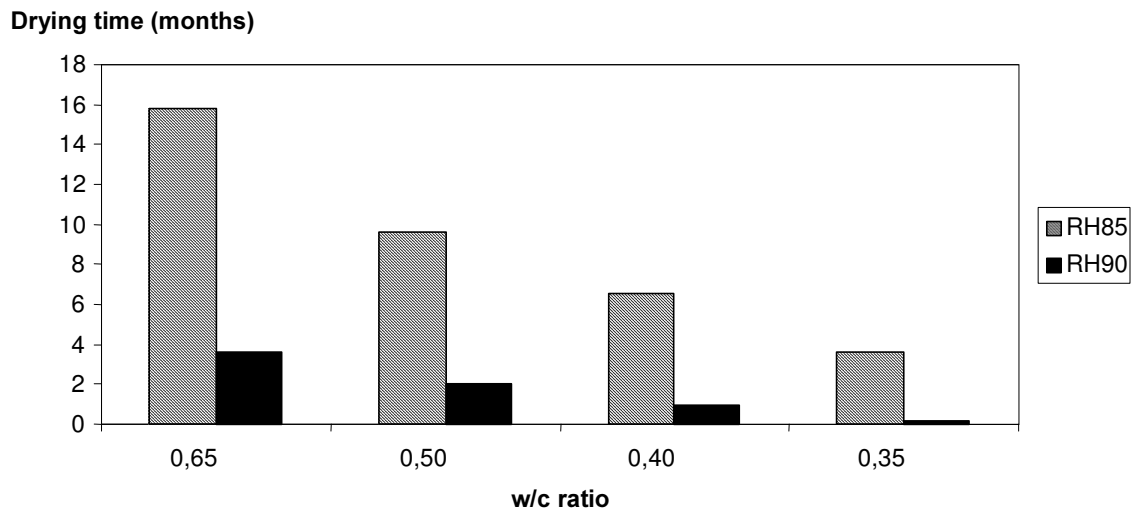

Figure 4.8 Estimated effects of various w/c ratios on the concrete drying time for Climate 2. Constant type of formwork (permanent concrete elements, “Filigran”) and slab thickness (0,20 m) is used within the calculations. No silica fume.

As for Climate 1, the effect of a lowered w/c ratio gives a considerable reduction in drying time. The difference between Climate 1 (fig. 4.3) and Climate 2 is not very big. Climate 2 only leads to a couple of weeks longer drying time.

#### 4.1.1.4 Calculation for Climate 3 – estimation of drying time with regard to controlled drying 1 month after start of concrete casting (winter, default data)

##### Introduction

The third climate condition represents winter climate conditions based on the default surrounding air temperatures within TorkaS 1.0, using statistical weather data. The PC-program assumes that the concrete temperature is equal to the surrounding air temperature but protected from early freezing of concrete, i.e. no consideration is taken to the fact that warmed concrete is delivered wintertime and to the heat development during cement hydration.

##### Conditions

According to Figure 4.9, the controlled drying starts one month after casting. During the first ten days, 1 day of rain (or snow) will occur, based on the statistical weather data used by TorkaS 1.0. After ten days, the concrete will be covered and protected from further rains.

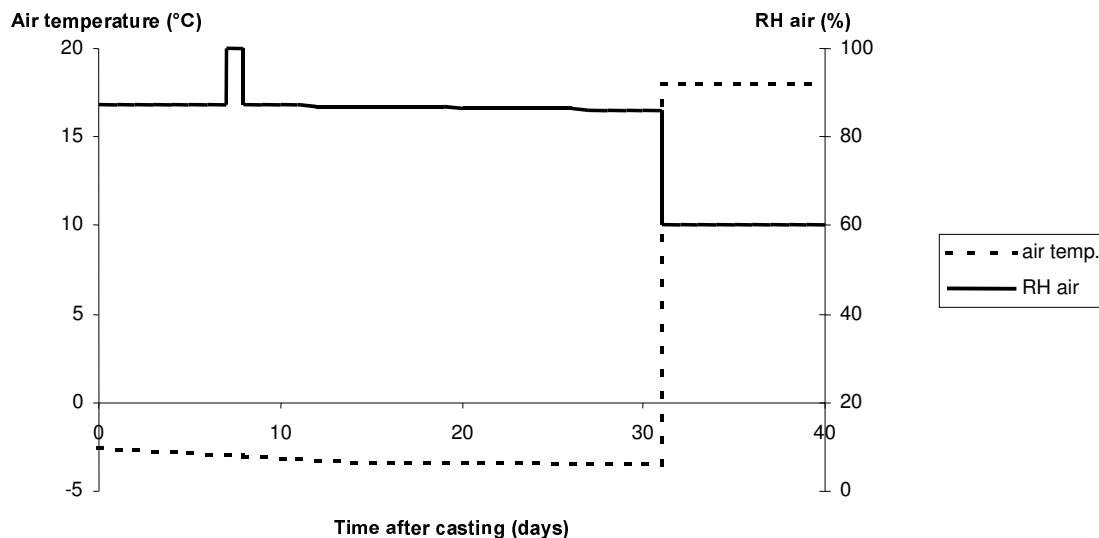

Figure 4.9 Surrounding climate conditions for Climate 3 during the first 40 days after concrete casting.

## Result

Figure 4.10 shows a considerable increase in drying time, compared to that shown in diagrams for Climate 1 and 2. This is an effect of the very slow cement hydration occurring at the very low concrete temperature used in the calculations (concrete temperature equals outer temperature).

### Drying time (months)

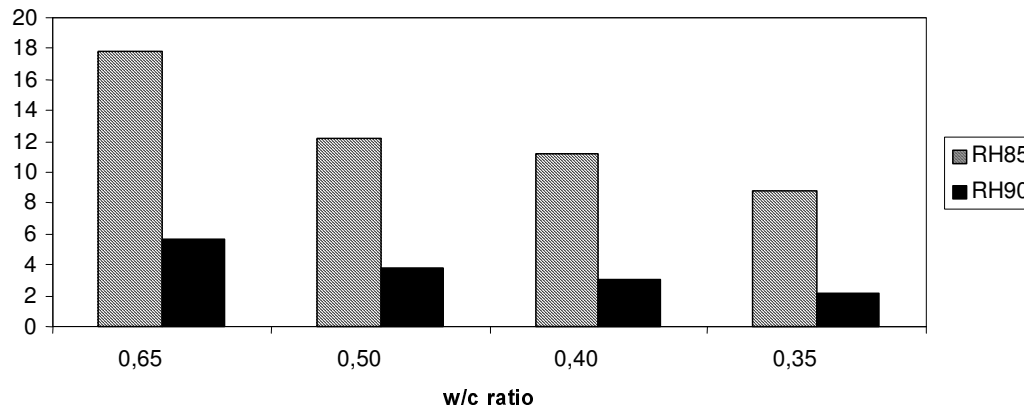

Figure 4.10 Estimated effects of various w/c ratios on the concrete drying time for Climate 3. Constant type of formwork (permanent concrete elements, “Filigran”) and slab thickness (0,20 m). No silica fume.

### 4.1.1.5 Calculation for Climate 4

– estimation of drying time with regard to controlled drying 1 month after start of concrete casting (winter, temperature constantly 10°C first 7 days after casting)

#### Introduction

The normally occurring increased temperature level of the concrete during the first days after casting due to heat development during hydration, leads to faster strength development in cold surrounding temperatures and a reduced risk for early freezing of the concrete. A high concrete temperature is also positive for the drying process. In order to calculate the effects of a higher concrete temperature level, than that of Climate 3. Climate 4 simulates the real temperature conditions by using fixed concrete temperature of +10°C during the first week.

#### Conditions

As implied in Figure 4.11, the climate condition 4 simulates the concrete temperature is +10°C during the first 7 days after concrete casting. Thereafter and until controlled drying is taking place (from 8 until 30 days after casting), the concrete temperature is set to be equal to the surrounding air temperature. During this time the concrete will be unprotected from rain, which due to the statistical weather data leads to that one day rain will occur.

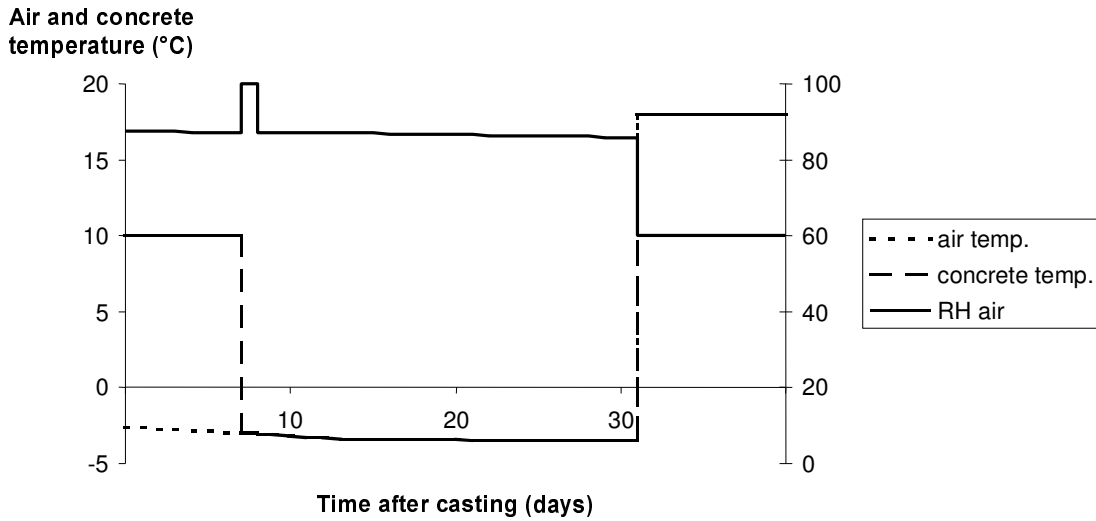

Figure 4.11 Surrounding climate conditions for Climate 4 during the first 40 days after concrete casting.

**Result**

The result for varying w/c ratio is shown in Figure 4.12. It displays a certain decrease of the required drying time for reaching a RH level of 85 and 90%, compared to the climate condition 3 (Figure 4.10). Thus, the fact that the concrete is warmer during the first week has a positive effect on drying.

**Drying time (months)**

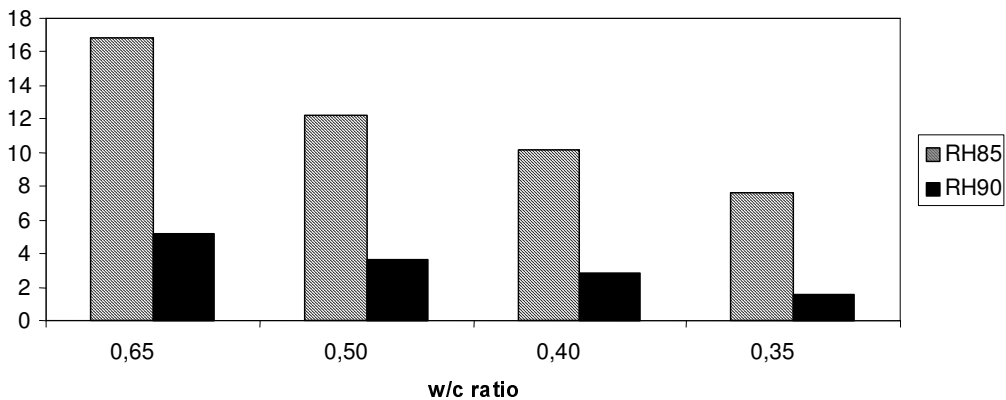

Figure 4.12 Estimated effects of various w/c ratios on the concrete drying time for Climate 4. Constant type of formwork (permanent concrete elements, "Filigran") and slab thickness (0,20 m) is used in the calculations. No silica fume.

#### 4.1.1.6 Calculation for Climate 5

– estimation of drying time with regard to controlled drying 1 month after start of concrete casting (winter, temperature calculated by Hett97 during the first 4 days)

##### Introduction

Methods for protecting concrete from early freezing and/or from obtaining slow rate of hydration during cold surrounding air temperatures are, for instance, covering of the concrete surface, insulation of the formwork and heating the concrete. This can be done in combination with utilising the larger heat development in concrete qualities with high cement content compared to ordinary house building concrete. As mentioned, the early hydration of the concrete affects the drying process, especially the self-desiccation in concrete with low w/c ratio. The calculations using Climate 5 aims at simulating larger but probably more realistic heat development and hydration, in comparison to the other winter climate conditions studied (Climate 3 and 4).

##### Conditions

For Climate 5, realistic concrete temperature development data have been utilised by importing result from the PC-program Hett97 (1997), which simulates temperature, maturity and strength development in concrete constructions for various concrete qualities, types of constructions, weather conditions etc. Figure 4.13 shows the average concrete temperature according to Hett97, during the first 4 days after casting. The calculations with Hett97 are based on outer climate conditions, similar to the climate conditions for Climate 5 (see Figure 4.14). The diagram shows the result when formwork system of “Filigran” is used, slab thickness 0,20 m, concrete temperature at casting 20°C, infra heating (350 kW/m<sup>2</sup>) during the first 24 hours and “high-quality” covering (definition according to Hett97).

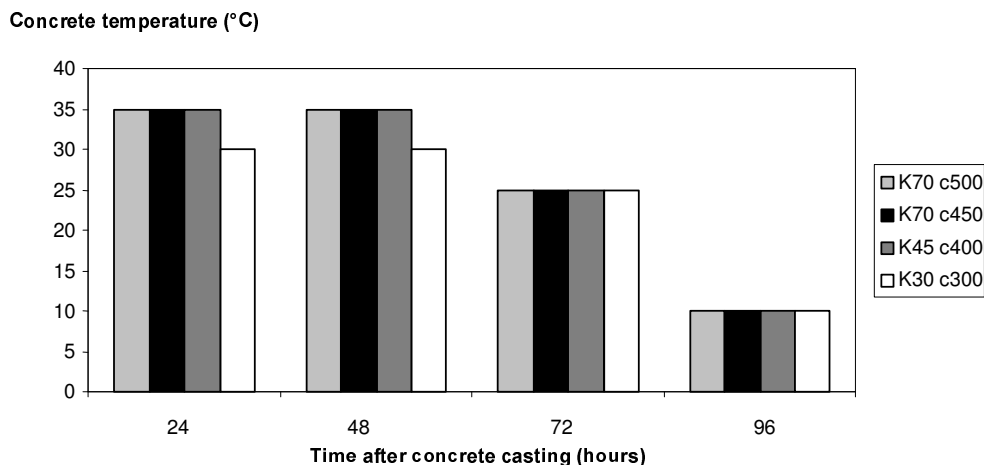

Figure 4.13 Used concrete temperature data during the first four days, based on calculations through the PC-program Hett97 (1997) for the surrounding air temperature of Climate 5. Slab thickness 0,20 m, Filigran-form, concrete temperature at casting 20°C, infra heating (350 kW/m<sup>2</sup>) during the first 24 hours and “high-quality” covering (definition according to Hett97).



As shown in Figure 4.14, the concrete will, as in the case of other winter climate conditions (Climate 3 and 4), have a temperature equal to the surrounding air temperature (based on statistical weather data) from the 5<sup>th</sup> day until the 30<sup>th</sup> day after casting. After the fourth day the concrete will be non-covered and therefore be affected by one day of rain (due to the statistical weather data) until the tenth day, when covering (protection from rain) will take place.

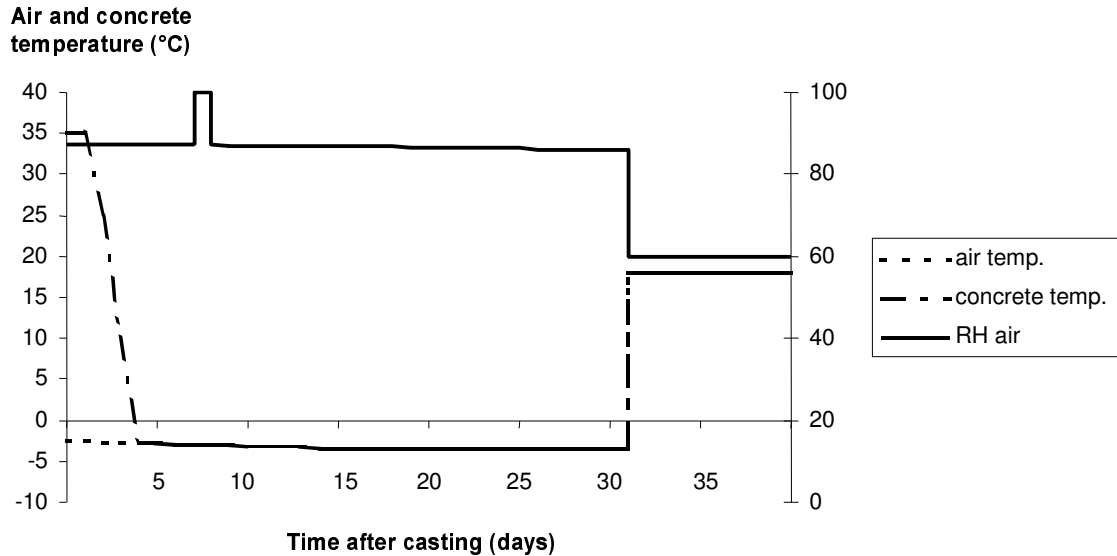

Figure 4.14 Surrounding climate conditions and concrete temperature for Climate 5 during the first 40 days after casting.

## Result

The required concrete drying time for Climate 5 can be seen in Figure 4.15. Additional information is given in section 4.1.1.7 “Effect of concrete temperature”. A comparison of the results in Figure 4.15 with the results for Climate 4 in Figure 4.12 shows that the calculated drying time is shortened by about 1 ½ to 2 months for concrete with low w/c-ratio when realistic concrete temperature is used. For concrete with higher w/c-ratio, the effect is smaller. This indicates that concrete temperatures mostly affect the self-desiccation, which in turn is more favorable in Climate 5 than Climate 3. For normal concrete, physical drying is more important. The rate of physical drying is less dependent on concrete hydration. Therefore, for NPC the Climates 3, 4, and 5 give almost the same drying time.

### Drying time (months)

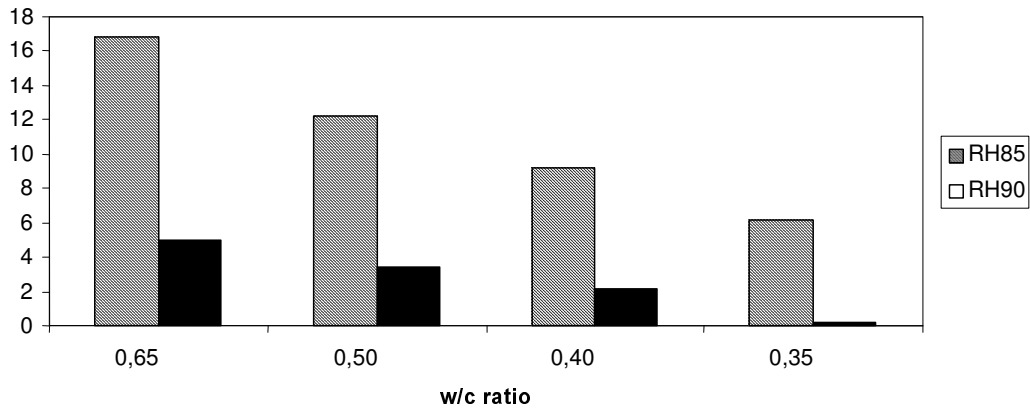
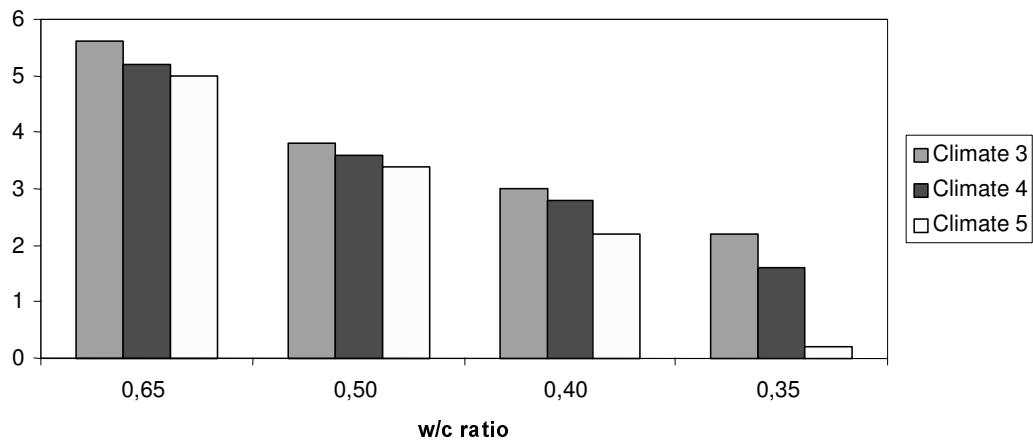

Figure 4.15 Estimated effects of various w/c ratios on the concrete drying time for Climate 5. Constant type of formwork (permanent concrete elements “Filigran”) and slab thickness (0,20 m) is used within the calculations. No silica fume.

### 4.1.1.7 Effect of concrete temperature

Comparison of results regarding the winter climate conditions (Climate 3-5) for different w/c ratio is presented in the Figure 4.16 “a” and “b”.

### Drying time (months)



a

### Drying time (months)

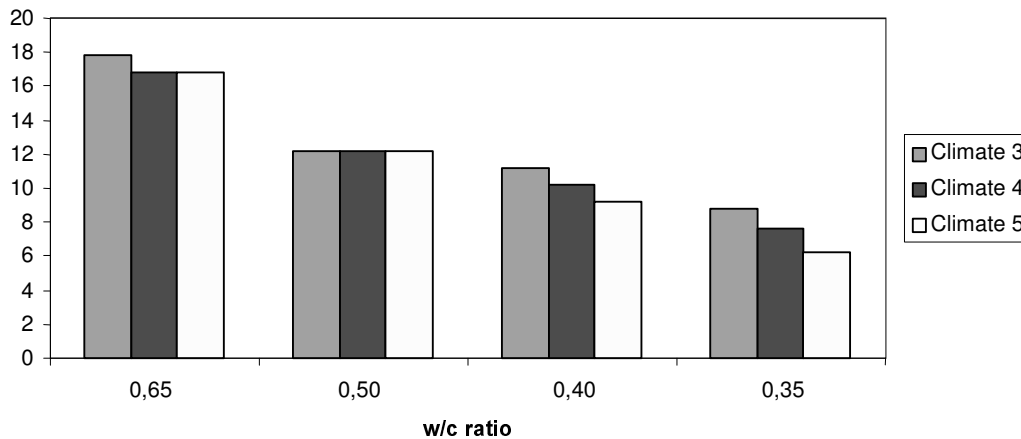

b

Figure 4.16 Effect of different early concrete temperatures on the calculated required drying time for reaching RH 90% (a) and 85% (b). Constant type of formwork (permanent concrete elements, “Filigran”) and slab thickness (0,20 m) is used within the calculations. No silica fume.

### Analysis/conclusions

As seen in Figure 4.16 “a” and “b”, the difference in required drying time between different simulated concrete temperatures during the first days are larger for HPC than for NPC. The effect can be explained as follows.

Drying depends on the mechanisms: (1) self-desiccation caused by volume reduction of chemically bound water, (2) physical drying caused by moisture transport to the surface. For HPC, self-desiccation is the dominant mechanism. It is very much affected by the rate of cement hydration. This increases with increased concrete temperature. Therefore, Climate 5 is more favourable than Climate 4.

Two conclusions can be drawn concerning the effect of concrete temperature on drying and on the use of TorkaS 1.0 for estimating the drying time:

1. Calculations by TorkaS 1.0 show that the selected value of concrete temperature has very big effect on the calculated drying time, especially for concrete with low w/c-ratio. Thus, it is recommended that as precise values as possible for concrete temperature are used as input parameter in TorkaS 1.0, and not the outdoor temperature. They can be calculated by the PC-program Hett97.
2. The results show the importance of using winter concreting methods that give rapid hydration when efficient drying process and rapid drying times are required. Thus, the use of warm concrete, high cement content, rapid cement, heat-insulated formwork, heating of concrete by infra-heaters and early covering of the concrete surface are essential.

#### 4.1.1.8 Effect of outer climate conditions

Figure 4.17 “a” and “b” present the effect of the five climate conditions studied on the required drying time for reaching 90% and 85% RH.

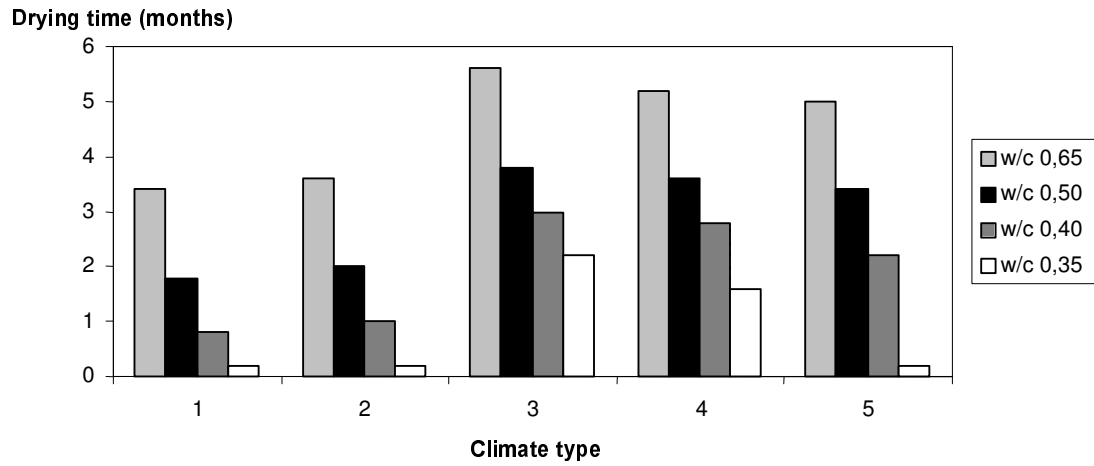

a

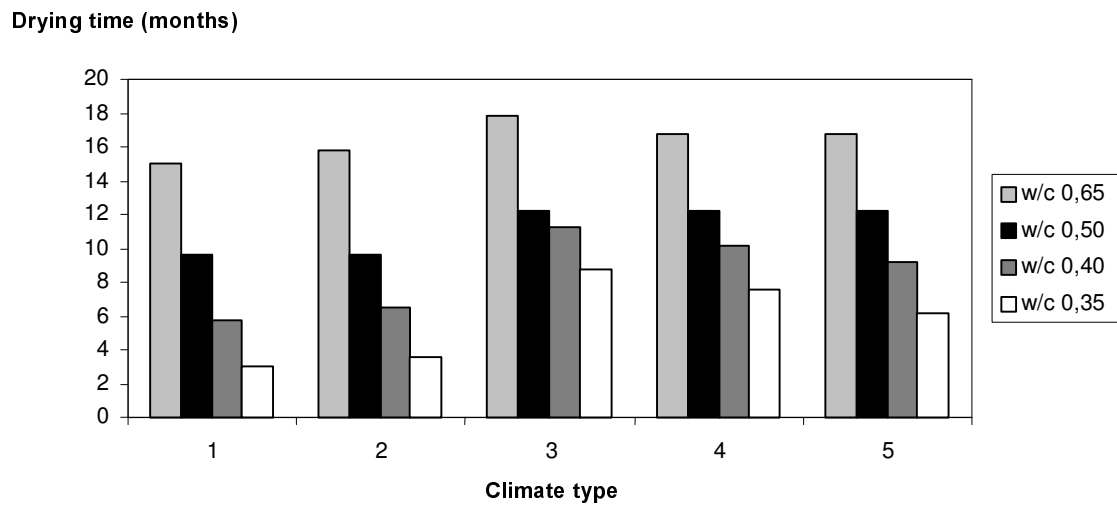

b

Figure 4.17 Comparison of results from all studied climates on the required drying time for reaching RH 90% (a) and 85% (b) for various w/c ratio. Constant type of formwork (permanent concrete elements, “Filigran”) and slab thickness (0,20 m) is used within the calculations. No silica fume.

#### 4.1.1.9 Analysis

The difference in required drying time for different climate conditions is significantly smaller for NPC than for HPC, especially when the required RH level is set to 85%. Several conclusions can be made. For instance, according to Figure 4.17 b (required RH of 85%), utilisation of controlled drying from the start of casting through weather-protecting tents, which is an expensive method, only reduces the drying time of NPC (w/c 0,65) from 16 (Climate 2) to 15 months (Climate 1) during summer conditions, and from 18 (Climate 3) to 15 months (Climate 1) during winter conditions. The same comparison but considering HPC (w/c 0,35) also indicates a small difference during summer conditions. During winter conditions though, the difference in drying time is significantly larger, 6 months (Climate 5) compared to 3 months (Climate 1).

When 90% is used as required RH level, a clear difference in drying time with regard to surrounding climate conditions also can be seen for NPC (w/c 0,65), 3,5 months (Climate 1) compared to 5 months (Climate 5).

Thus, the high importance of providing for good conditions for early rapid hydration, causing rapid self-desiccation, is most pronounced for HPC during wintertime.

Another conclusion is, that for all studied climates, HPC leads to significantly reduced required drying time. For Climate 1, the drying time can be reduced from 15 to 3 months and for Climate 5, from 17 to 6 months, when HPC is utilised instead of NPC.

#### 4.1.1.10 Discussion

The results of the study reveal in what degree the studied parameters water/cement ratio, silica fume content, slab thickness and type of formwork affect the concrete drying time for different types of surrounding climate conditions. Limitations of the parameters and climate conditions have had to be made. However, values of the variables are intended to correspond to realistic conditions.

There are also limitations in the used calculation tool, the PC-program TorKaS 1.0. In order to simulate the drying time for constructions cast in winter, real concrete heat development data during the first days after casting have been used instead of the default data used in the original version of program. These changes are assumed to be more correct compared to the original data, especially for HPC.

Another aspect of the use of TorKaS 1.0 is that the required drying time in reality may be different from the calculated. Probably the calculated values are too big. However, the calculations aim at presenting the potential for shorter drying times using HPC, and there are no risks for that calculated drying times are shorter than the real.

Generally, decreased w/c ratio and slab thickness together with increased content of silica fume reduces the drying time significantly for all studied climates. Another result is that Filigran-formwork leads to shorter drying times compared to steel forms, due to that double sided drying is enabled instead of single direction drying. Comparing ordinary concrete with w/c ratio of 0,65, steel form and without silica fume to HPC containing silica fume, with w/c ratio of 0,35 and Filigran-form, leads to a significant difference in required drying time. To

reach a relative humidity of 85%, the first concrete concept requires a drying time of more than 20 months and the latter about two months.

#### *Effects of self-desiccation*

A low w/c ratio reduces the drying time significantly due to the self-desiccation effect. Besides, concrete with a high degree of self-desiccation is less sensitive to variations such as slab thickness, use of steel form etc. The self-desiccation effect can in other words be utilised for a more versatile way of building, since aspects that normally affect the drying time can be more or less ignored. The advantages of using self-desiccating HPC for obtaining good acoustic indoor quality are obvious. When using normal concrete, good acoustic quality requires thick concrete slabs, but this will give unacceptable long drying time if NPC is used. By using HPC, thick slabs can be produced with short drying times.

In order to utilise the self-desiccation effect of HPC when casting in winter, it is important to use winter concrete protection methods, in order to create high-quality conditions for concrete hydration. Otherwise, a significant difference in drying times will occur.

#### *Silica fume*

Regarding silica fume, the result of the calculation displays an obvious effect on the drying time. For instance, a reduction of drying time between 30 and 50% is possible when a silica fume content of 5% is used during Climate 1. The reason for the positive effect of silica fume is that it increases self-desiccation.

#### *Winter concreting*

Three types of temperature data concerning winter casting have been used. The first climate condition uses the default values within the PC-program TorkaS 1.0. For the second condition the concrete temperature has been set to constantly 10 °C during first week. For the third climate condition, concrete temperature data from the PC-program Hett 97 have been used. The difference between the three types of climate is relatively big. Especially for HPC, the differences in drying time are significant. According to earlier mentioned explanations, the reason for this is that HPC to a larger extent is dependent on rapid hydration for the self-desiccation effect to be efficient.

#### *Controlled drying- weather protections*

The most efficient climate for a reduced drying time is of course Climate 1, where controlled drying starts immediately after the concrete is cast. For the other climates, the controlled drying is assumed to start after one month. As shown in figures 4.17 “a” and “b”, the difference between the summer climates 1 and 2, where the latter simulates controlled drying after one month, is much smaller than the difference between Climate 1 and 3-5, where the concrete is cast wintertime and protected by various winter concrete methods.

### **4.1.1.11 Conclusions**

According to the analysis, the main positive effects of HPC, compared to NPC, concerning drying time are as follows:

- HPC leads to significantly shorter drying times for all studied climate conditions (20-50% of drying time required for NPC)

- Drying of HPC is nearly independent of the concrete slab thickness
- HPC creates possibilities for short drying times even when impermeable formwork systems as steel (leading to drying in one single direction) are used

Other conclusions concerning concrete drying are:

- **Formwork**  
For NPC, formwork that does not allow drying in two directions (e.g. steel) leads to approximately 70% increase in drying time for a 20 cm slab, compared to Filigran-formwork, which enables drying in two directions.
- **Silica fume**  
Concrete (w/c ratio of 0,35 to 0,50) including silica fume needs approximately about 2/3 of the required drying time, compared to concrete without silica fume, for reaching 85% RH on the equivalent depth.
- **Concrete slab thickness**  
If the concrete slab thickness is increased from 0,15 to 0,25 meters, the required drying time for NPC for reaching 85% RH will be extended by 100% when Filigran-formwork is used.
- **Concrete temperature during the first days after casting during wintertime**  
In order to utilise the self-desiccation effect of HPC, rapid hydration during the first days after casting is important. Therefore it is important to use high quality protection of the concrete during the first days.
- **Surrounding climate conditions**  
For HPC, the drying time for reaching RH 85% when controlled drying is used from casting (Climate 1) is 50% of the time required for the realistic Winter climate 5. Similar comparisons regarding NPC though, result in smaller differences. For NPC to reach RH 85%, the required drying time in Climate 1 is 90% of the drying time required for Climate 5.

#### **4.1.1.11 Utilisation of result for rationalised production**

The results of the study show examples of benefits in the form of reduced drying times by utilisation of HPC. This may create possibilities for reduction of the total production time. The study does not only estimate the potential of HPC but also the effects of other parameters on the concrete drying time for NPC and HPC. Analysis of economical aspects is not the aim of the study, since this is limited to estimating the potential for reduced production time. The influence of the drying time on the total production time is assumed to be complex and to a large extent related to the type of building project. To calculate detailed economical benefits, field studies are probably required.

There are some potential risks with HPC that have not been analysed within this chapter. Such risks are reduced workability, increased risks for emissions from flooring materials etc. These and other risks might be some obstacles for a wide utilisation of HPC. See further Chapter 6 “Obstacles for the implementation of new concrete materials technology”.

## **4.1.2. Utilisation of HPC for rapid strength development**

### **4.1.2.1 Introduction**

#### **Background**

The production cycles for cast in-situ concrete may be strongly dependent on the required time until stripping the formwork and/or post-tensioning of reinforcement can be made. This time depend on the rate of strength development of the concrete, which in turn, to a large extent depends on the concrete quality and surrounding air temperature. Winter conditions including cold air temperature significantly decrease the rate of strength development and thereby also increase the required formwork stripping time. There are also the risks for early freezing of the concrete that may lead to risks for serious damage of the construction. To increase the strength development of concrete, the cement content is often increased and during winter conditions, external protection methods as insulating the formwork, covering the concrete surface and heating of the concrete (by using infra-heaters) may have to be utilised in order to increase the strength development and protect the concrete from early freezing.

#### **Aim**

The study aims at estimating the potential for reduction of production time, by utilising the rapid strength development of HPC caused by the high cement content and low water/cement ratio. Studied areas concentrate on presumptive beneficial effects of HPC, as for instance decreased time required until formwork stripping and post-tensioning of reinforcement can be made, and reduced risk for early freezing of the concrete during winter conditions. Required time to reach specific strength levels and risk for early freezing with regard to various climate conditions and production methods are estimated and comparisons between NPC and HPC are made.

The study is divided into the following main parts: (1) strength development for formwork stripping, (2) strength for post-tensioning of reinforcement and (3) the risk for freezing. All three parts include the subsections: (1) introduction, (2) calculations, (3) result and (4) conclusions. Finally, the study ends with a discussion of the results and summarised conclusions.

#### **Method**

Parameter studies of variables influencing the strength development in concrete slabs are carried out by the PC-program Hett97 (1997). This PC-tool estimates the development and gradients within the cross-section of temperature, age of maturity and compression strength in various types of concrete structures. Further, Hett97 includes various concrete qualities by using tendency curves for the strength development of different concrete types. The tendency curve gives the strength development for a constant reference temperature (+20°C). A number of construction types can be analysed (e.g. walls, columns, slabs on ground and slabs including various formwork systems). The input data concerning surrounding conditions are, for example, temperature of concrete at casting, air temperature, wind conditions, covering, insulation and heating of concrete.



The influence of various concrete qualities in combination with different outer conditions are simulated with the aim of estimating the difference between HPC and NPC concerning time required for reaching a concrete strength of 20 MPa and also the risk for early freezing of the concrete structures (required strength level is 5 MPa before freezing). The results of the calculations are presented as diagrams in each result section.

#### **4.1.2.2 Early stripping of formwork**

##### **Introduction**

Construction codes include requirements for concrete compression strength when stripping the formwork, in order to eliminate the risk for collapse. Concerning concrete slabs, the Swedish Building norm requires a minimum strength of 70% of the strength class required for the concrete construction. The required concrete compression strength regarding vertical formwork needed for walls is set to 6 MPa according to the Swedish building norm. On the market there are a number of measurement systems to estimate the strength level of concrete. For all systems it is important to conduct the measurement in relevant parts of the structure. In concrete slabs, measurement should be conducted in zones with the highest compressive stress and in walls at the outer surface of the lower parts, where stresses are highest and temperature (hydration) lowest.

Stripping of slab formwork during summertime can normally be made a few days after casting but can nevertheless be a critical parameter with regard to the total production time when demands on rapid production are high, especially during the colder parts of the year. For walls, the normal stripping time is less than 24 hours, and this time should preferably be kept during cold weather. There are a number of solutions for reducing the required time for removal of formwork. One often-used method is to increase the amount of cement, which means a decrease of the w/c ratio. Summertime, a moderate increase in strength class (from K30 to K40 or K50) significantly reduces the formwork stripping time. During the cold part of the year though, when the air temperature falls to levels around or below zero, increased concrete quality often is supplemented by external winter concrete methods, as for instance heat insulation, covering of the surface and heating of the concrete. However, utilisation of concrete strength classes corresponding to HPC, which according to the Swedish tradition requires concrete compression strength of at least 80 MPa, with the main aim of decreasing the formwork removal time is seldom practised, neither in summer nor in winter.

Within the study, formwork-stripping time is calculated by simulating important parameters. The calculations aim at comparing HPC with NPC, assessing different winter concrete methods and different kinds of climate and formwork. Only slabs are considered.

##### **Calculations**

Table 4.3 displays the parameters investigated. The values of these have been varied, in order to investigate the effect of the early strength development of concrete.

Due to the fact that the concrete types considered within the PC-program are limited to a maximum strength level of 70 MPa, the two highest concrete qualities (K90 and K110) have been manually introduced in the PC-program by increasing the cement content with 30 kg/m<sup>3</sup>

per strength class together with increasing the strength of 28 days maturity to the actual K-values. Used type of cement is in all simulated cases of type Swedish Std Portland. The slab thickness is permanently set to 0,20 meters. Studied form types are plywood with a thickness of 19 mm and Filigran with a thickness of 50 mm. For simulations for summertime, the surrounding air temperature is constantly set to 15 °C and during winter time, three levels of air temperature are simulated, 0, -5 and -10 °C. Concerning external winter concrete methods, aiming at utilising the internal concrete heat development during the first couple of days after casting, three types are simulated: heating the form/concrete from below using infra heaters (350 kW/m<sup>2</sup> during the first 24 hours), “well-insulating” heat insulation of the formwork (definition according to Hett97) and “high-quality” covering of the concrete from above (definition according to Hett97). The concrete temperature at casting has for simulations during summer climate been set to 15 °C and during winter to 20 °C, which means that during winter, the concrete has been heated in the concrete factory to a level that can be regarded as a standard value for Swedish winter conditions. Also +25 °C has been considered.

The required level of strength at stripping of formwork has for all simulations within the study been set to 20 MPa that is a common required level in practice. The Swedish norm requires a minimum level of 70% of the total strength required with regard to design aspects when stripping the formwork. This value (70%) is, however, in most cases much too high for HPC.

*Table 4.3 Studied parameters within the production related study of early strength development*

| <b>Parameters</b>                    | <b>Levels</b>                                    |
|--------------------------------------|--|
| Concrete strength class (K-value)    | 30, 50, 70, 90 and 110 MPa                       |
| Cement content (Std Portland)        | 270, 420, 450, 570 and 690 kg/m <sup>3</sup>     |
| Slab thickness                       | 0,20 m   |
| Types of forms                       | Plywood (P) 19 mm and Filigran (F) 50 mm         |
| Air temperature                      | Summer (15 °C) and Winter (0, -5 and -10 °C)     |
| Heating of concrete by infra heaters | Yes (350kW/m <sup>2</sup> 24hours) and no (none) |
| Heat insulation of formwork          | Yes (“well-insulated”) and no (none)             |
| Covering                             | Yes (“high-quality” 672 hours) and no (none)     |
| Concrete casting temperature         | Summer (15 °C) and Winter (20 and 25 °C)         |

## **Result**

The time required for reaching 20 MPa for various concrete strength classes, from NPC (K30) to HPC (K110), during summer conditions (outer air temperature of 15 °C) is shown in Figure 4.18. An increase to K50 from K30 leads, independent of formwork type, to a significant reduction of time required (1 day in relation to 5 days) for reaching the strength level of 20 MPa in the slab. When using an even higher concrete quality (e.g. K110), the time required can be reduced to approximately 0,5 day.

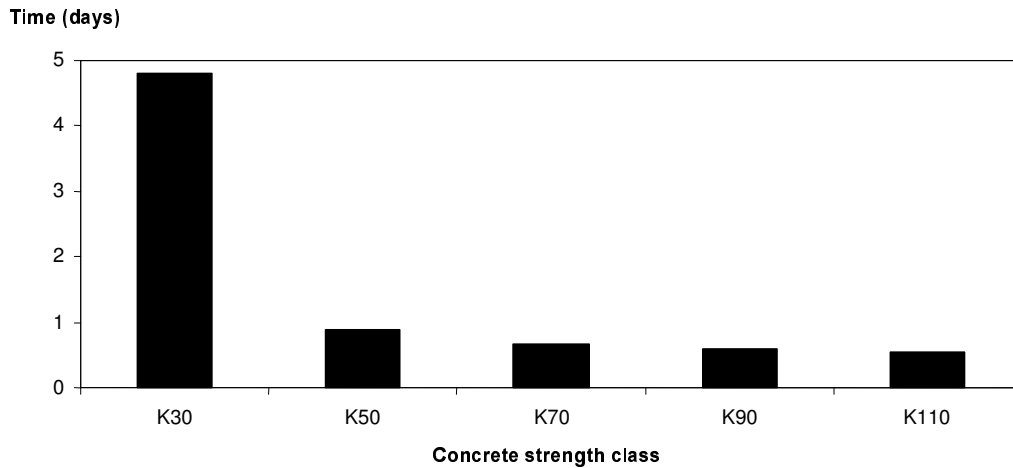

Figure 4.18 Calculated time required for reaching 20 MPa for various concrete strength classes (summer conditions). 19 mm plywood form.

The effect of cold winter climate is clearly displayed in Figure 4.19. With a surrounding air temperature of 0 °C an increase from K30 to K50 leads to a significant reduction of the stripping time required, but with an outer air temperature of -5 °C, an even higher strength class is required if short time is wanted. Only when using a strength class as high as K90, the time required is less than 10 days. The table also shows that when the outer air temperature is as low as -10°C, a high strength class is not enough if an acceptable stripping time is wanted. Note that none of the analysed structures include any winter concrete methods. The result is based on simulations where only plywood is used as formwork system and the concrete is not heated by infra-heaters, heat insulated or covered.

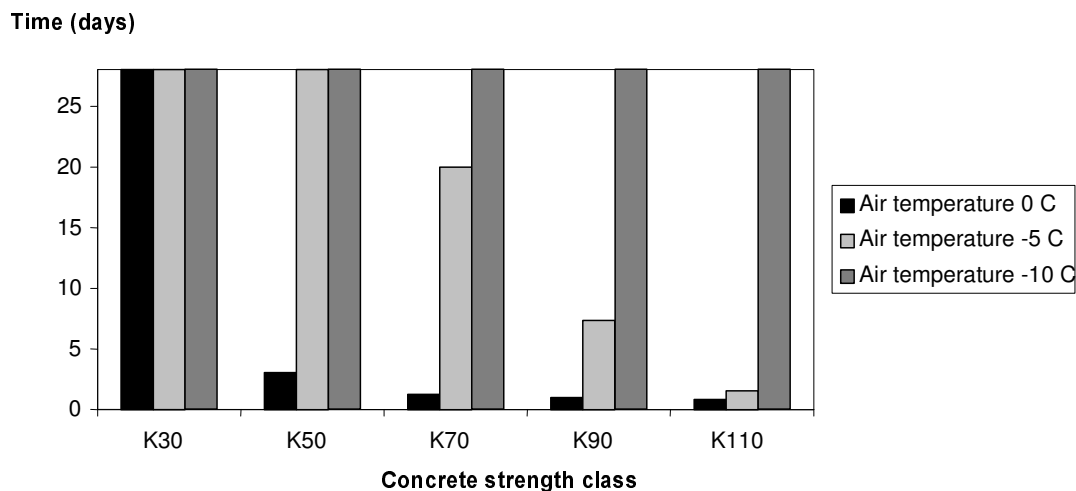

Figure 4.19 Calculated time for reaching 20 MPa in concrete of different strength class at different outer air temperatures. No winter precautions. Only 19 mm plywood form. Casting temperature +20°C.

Calculations of the effect of type of non-insulated formwork on the time for reaching 20 MPa at outer temperature -5°C are shown in Figure 4.20. The highly negative effect of using non-

insulated concrete Filigran-elements is obvious. The high difference between plywood and Filigran-formwork reflects the much lower heat conduction coefficient of wood.

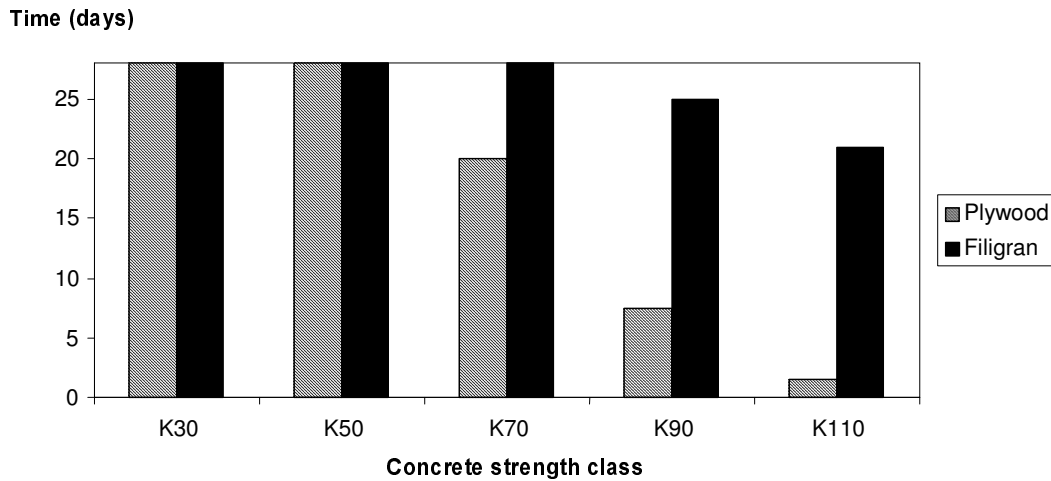

Figure 4.20 Calculated time to reach 20 MPa at an outer temperature of  $-5^{\circ}\text{C}$  and use of non-insulated form and no winter precautions. Casting temperature  $+20^{\circ}\text{C}$ .

The effect of utilising all winter concrete methods simultaneously (heat insulated formwork, covered concrete surfaces and heated concrete by infra-heaters) is shown in Figure 4.21. The result is based on a surrounding air temperature of  $-5^{\circ}\text{C}$  and that plywood has been used as formwork. The diagram shows a significant reduction of time required for reaching the strength level of 20 MPa for all studied concrete strength classes when all studied winter concrete methods are used together simultaneously. The time required to reach 20 MPa for K30 and K110, when both are including winter concrete methods are approximately 1 day and 0,2 days respectively. In comparison, a K110 concrete without winter concrete methods needs 1,5 days for reaching 20 MPa.

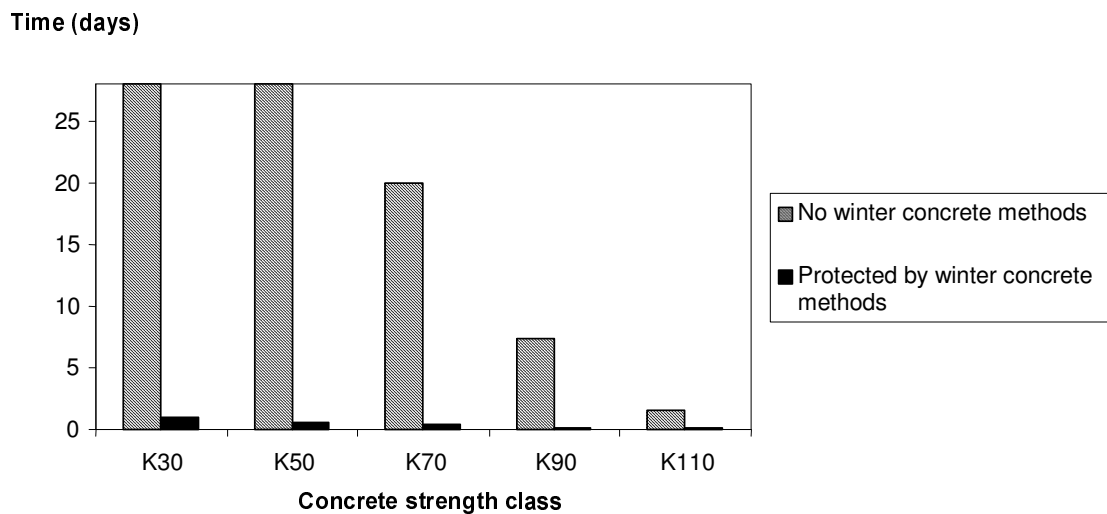

Figure 4.21 Calculated time to reach 20 MPa at outer temperature of  $-5^{\circ}\text{C}$ . Effect of winter precaution activities. 19 mm plywood form. Casting temperature  $+20^{\circ}\text{C}$ .

The effect of the winter concrete precaution activities separately and in various combinations, is presented in Figure 4.22. An insulated K70 leads to nearly the same form stripping time as a K30 that is protected by insulation, covering and heating. The result is based on an outer air temperature of  $-5^{\circ}\text{C}$ .

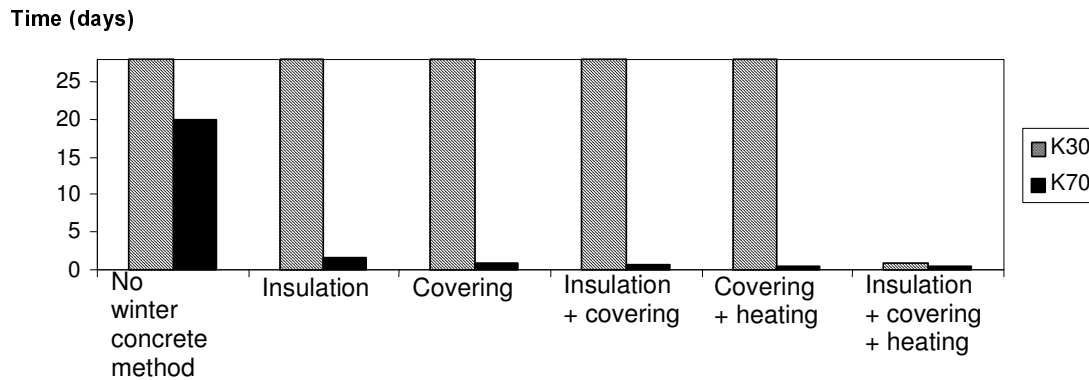

Figure 4.22 Example of the effect of different winter precaution activities on the time needed to reach 20 MPa at an outer temperature of  $-5^{\circ}\text{C}$ . 19mm plywood form. Casting temperature  $+20^{\circ}\text{C}$ .

### Early formwork stripping – Conclusions

There are a number of factors that can be optimised to minimise the time required for reaching a specific strength level required for stripping of the formwork. An increase of the concrete quality, causing more rapid early strength development, can significantly reduce the time required. This is valid during summer as well as during winter. Depending on surrounding air temperature, there are various combinations of concrete strength classes and winter concrete methods that can be used in order to reach a specific strength value at a specific time.

According to Figure 4.19, an ordinary house-building concrete without use of any winter concrete protective methods is not enough to get short (or normal) form stripping time. For an outer air temperature of  $0^{\circ}\text{C}$ , an increase in concrete quality from K30 to K50 leads to a significant improvement in terms of reduced stripping time. For lower air temperatures like  $-5^{\circ}\text{C}$ , HPC (K90 or higher) is needed in order to get a satisfying strength development when no winter concrete methods are used. With an air temperature of  $-10^{\circ}\text{C}$ , even a K110 concrete is not enough, unless winter protective methods are used.

It is quite clear from the result that concrete has to be protected during wintertime castings. Figure 4.21 shows that an ordinary K30 concrete including all winter concrete methods used together (insulation, covering and heating), leads to approximately the same strength development time required as a K110 concrete without any winter concrete protective methods. When studying the effects of various winter concrete methods separately (Figure 4.22), a K110 concrete including only insulation and/or covering leads to approximately the same strength development time required as a K30 concrete including both insulation, covering and heating.

### 4.1.2.3 Freezing of concrete

#### Introduction

Concrete casting when the surrounding air temperature is below 0°C may lead to early freezing of the water in concrete, which causes a severe risk for frost damages in the concrete. To prevent such damages, the Swedish building code includes requirements for a compression strength of minimum 5 MPa before the concrete temperature is allowed to fall below 0°C. When measuring the compression strength of concrete, which has started to freeze, there might be risks for false overestimations of the strength as a result of that the strength of ice is included. When the ice melts, the real strength of the concrete will be reduced dramatically, which in worst case may lead to serious safety problems as result. The reason to that 5 MPa is used as criterion is not that 5 MPa is high enough to sustain the stresses occurring at freezing, but that 5 MPa corresponds to an internal drying caused by hydration that is big enough to take care of the 9% volume increase, when water is transformed to ice, Fagerlund (1980).

The internal temperature of concrete increases during the first days after casting, even when the outer air temperature is low. However, at an air temperature below 0°C, the risk of freezing is high also in concrete of high quality, if no external winter casting concrete methods are utilised. The most common methods to increase the strength development of concrete during cold outer temperatures are, as already mentioned insulation, covering and heating of concrete. As an alternative to the external methods, an increase of the concrete quality may be enough with regard to early strength development and elimination of the freezing risk, provided that the temperature is not too low.

The aim of this part of the study is to estimate the potential of HPC for reducing or eliminating the risk of early freezing concrete. The freezing risk of HPC combined with/without external winter concrete methods are calculated and compared to NPC with/without external winter concrete methods.

#### Calculations

Similar calculations as performed in the previous section of the chapter, regarding early strength development, are conducted with the aim of calculating the strength level in the concrete structure when the minimum internal concrete temperature passes below 0°C. The PC-program Hett97 has been used. With the aim of estimating the differences regarding freezing, protecting methods for HPC and NPC, various external winter concrete methods and surrounding air temperatures are simulated. The cement type is Swedish Std Portland. Only 20 cm thick slabs are considered.

#### Result

The first results concern the effects of surrounding air temperature on the freezing risk of concrete, i.e. freezing before the strength has reached 5 MPa, see Table 4.4. Other parameters are concrete quality and winter protective methods.

Note that the result is based on a concrete temperature at casting of +20 °C, formwork of plywood and that winter casting methods consist of heat insulation, covering and heating by infra-heaters of concrete. The details of these methods are described in 4.1.2.

The table shows that no studied concrete will freeze if all winter concrete methods are used simultaneously. Further, if no winter concrete precaution methods are used, a concrete quality of at least K90 is required when the surrounding air temperature is -5°C.

*Table 4.4 Estimated risk of early concrete freezing with regard to the surrounding air temperature, concrete quality and utilisation of winter concrete methods. Plywood 19 mm is used as formwork. Temperature of concrete at casting 20°C. Winter concrete methods consist of a combination of insulation, covering and heating of concrete. Swedish Std Portland cement.*

| <b>Air temp</b>                          | <b>K30</b><br>(c=270kg/m <sup>3</sup> ) | <b>K50</b><br>c=450kg/m <sup>3</sup> ) | <b>K70</b><br>c=470kg/m <sup>3</sup> ) | <b>K90</b><br>c=590kg/m <sup>3</sup> ) | <b>K110</b><br>c=690kg/m <sup>3</sup> ) |
|--|---|--|--|--|---|
| not protected by winter concrete methods |   |  |  |  |   |
| -5                                       | r                                       | r                                      | r                                      | nr                                     | nr                                      |
| -10                                      | r                                       | r                                      | r                                      | r                                      | r                                       |
| protected by winter concrete methods     |   |  |  |  |   |
| -5                                       | nr                                      | nr                                     | nr                                     | nr                                     | nr                                      |
| -10                                      | nr                                      | nr                                     | nr                                     | nr                                     | nr                                      |

r = risk for frost damage      nr = no risk for frost damage

Table 4.5 presents the effects of each studied winter concrete method, used separately or in combination with other methods, on the freeze risk for various concrete strength classes (K30 – K110) and different internal concrete casting temperatures (20°C and 25°C). The potential of HPC is clear. For example a K70 concrete does not need to be protected against early freezing by external winter concrete methods if the concrete temperature at casting is 25°C. An ordinary K30 concrete requires both covering and insulation irrespectively of the casting temperature.

Another result is that heating of concrete is not required. However, heating of concrete is still an efficient method in order to reach a specific strength level with regard to formwork stripping, as described above.

Table 4.5 Estimated risk for early freezing of concrete depending on various winter concrete methods. The outer air temperature is constantly set to -10 °C. Plywood 19 mm is used for all calculations.

| K-value | Cement (kg/m <sup>3</sup> ) | Insulated form | Covering | Heating | Freeze risk<br>Concrete<br>temperature at<br>casting = 20 °C | Freeze risk<br>Concrete<br>temperature at<br>casting = 25 °C |
|---------|-----------------------------|----------------|----------|---------|--|--|
| 30      | 270                         |                |          |         | yes  | yes  |
|         |                             | x              |          |         | yes  | yes  |
|         |                             |                | x        |         | yes  | yes  |
|         |                             | x              | x        |         | no   | no   |
| 50      | 450                         |                |          |         | no   | no   |
|         |                             | x              |          |         | no   | no   |
|         |                             |                | x        |         | no   | no   |
|         |                             | x              | x        | x       | no   | no   |
| 70      | 470                         |                |          |         | no   | no   |
|         |                             | x              |          |         | no   | no   |
|         |                             |                | x        |         | no   | no   |
|         |                             | x              | x        | x       | no   | no   |
| 90      | 570                         |                |          |         | no   | no   |
|         |                             | x              |          |         | no   | no   |
|         |                             |                | x        |         | no   | no   |
|         |                             | x              | x        | x       | no   | no   |
| 110     | 690                         |                |          |         | no   | no   |
|         |                             | x              |          |         | no   | no   |
|         |                             |                | x        |         | no   | no   |
|         |                             | x              | x        | x       | no   | no   |

## Conclusions

If the temperature of the concrete passes below 0°C before the strength of the concrete has reached a level of 5 MPa, there are risks for freezing damages in the concrete structure. Different types of methods to protect against early freezing of concrete have been investigated. These methods consist of increased cement content (and strength), various external winter concrete methods (insulation, covering and heating of concrete) and various combinations of these variables. By using the PC-program Hett97, the effects of the methods are simulated for various types of formwork and surrounding air temperature. The study results in diagrams presenting the risks of early freezing of concrete with regard taken to protection methods and surrounding conditions.



Main conclusions are:

- When simultaneously utilising all studied winter concrete methods, there are no risks for early freezing of the concrete, independent of the concrete strength level, even if the surrounding air temperature is as low as  $-10^{\circ}\text{C}$  and the concrete temperature at casting is  $20^{\circ}\text{C}$ .
- A concrete quality of at least K90 is required for eliminating the risks for early freezing when no winter protecting methods are used at the same time as the outer air temperature is  $-5^{\circ}\text{C}$  and the temperature of the fresh concrete is  $20^{\circ}\text{C}$ .
- If the concrete temperature at the start of casting is  $25^{\circ}\text{C}$ , no external winter concrete methods have to be used regarding the risk for early freezing for concrete qualities of K70 or more, even if the surrounding air temperature is as low as  $-10^{\circ}\text{C}$ . For the same conditions, a K50 concrete needs heat insulation of the formwork and a K30 must be both insulated (of the formwork) and covered (of the concrete surface) to avoid early freezing of the concrete.

#### 4.1.2.4 Early post-tensioning

##### Introduction

In order to produce post-tensioned elements in a rational way, it is important that the concrete has a rapid strength growth. The strength required when post-tensioning can be made, depends on the type of element and is often more than 20 MPa. The same requirement for rapid strength growth is valid for in-situ casting, like “Freivor-Bau” of bridges. One can seldom wait more than 3 days until post-tensioning has to be made, in order that one shall be able to move the mould outwards.

##### Calculations

The calculations are similar to the ones performed before regarding stripping time of formwork. The value of required strength regarding post-tensioning of reinforcement is therefore set to 20 MPa, which is equal to the value set for stripping of formwork. As for the earlier calculations, the PC-program Hett97 is used as calculation tool, where the effects of various concrete qualities, surrounding air temperatures and winter concrete methods, on the strength development are estimated. Only the cast in-situ condition is considered. The cement type is of type Swedish Std Portland.

##### Result

Figure 4.23 shows the time required for reaching a concrete strength level of 20 MPa during summer conditions ( $15^{\circ}\text{C}$ ) as well as during winter conditions ( $-5^{\circ}\text{C}$ ). The member thickness is 0,20 m and the mould is 19 mm plywood. The result concerning winter conditions is further divided into two groups, based on whether external protecting winter concrete methods (insulation, covering and heating of concrete) are used or not.

Required time  
(days)

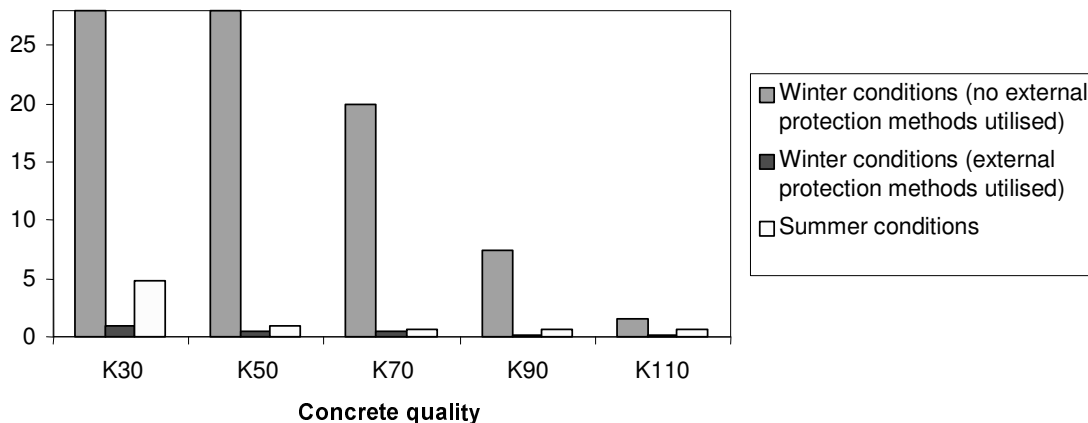

Figure 4.23 Time needed to reach a compressive strength of 20 MPa in a 0,2 m thick member cast in 19 mm Plywood form. Effects of concrete quality and winter precautions are shown. Swedish Standard Portland Cement.

#### 4.1.2.5 Summary of results and conclusions

##### Concreting during summer conditions

The result of the study concerning summer conditions shows that the time required for reaching a strength level of 20 MPa can be reduced by 80%, i.e. from 5 days to 1 day, when utilising a K50 concrete instead of a conventional house-building concrete K30. Furthermore a K110 concrete needs 0,5 day to reach the same strength level. This effect is caused by the lower w/c ratio in concrete with high strength and can be utilised for rapid form removal and/or early post-tensioning of reinforcement.

##### Concreting during winter conditions

The largest potential for utilising the rapid strength development of HPC is connected to winter conditions, especially when the surrounding air temperature passes below 0°C. Concrete qualities with different strength levels (K30 – K110) and various kinds of external winter protecting methods are analysed in the study, e.g. the use of form insulation, infra-heating of concrete, covering of the concrete surface and increased concrete casting temperature.

The analysis shows that there is a large potential for reducing the production time when utilising the fast strength development of HPC or in combination with winter protection method/methods. For an example the time required to reach 20 MPa can be reduced from more than 28 days to only 1 day, by using a K70 instead of K30, when only covering is used as winter concrete protection method and the concrete temperature at casting is 20°C and the outer air temperature is -5°C. Further a HPC (K110) without any winter protection methods, requires approximately the same time for reaching 20 MPa as a NPC (K30) furnished with heat insulation of formwork, covering of the concrete surface and heating of the concrete, for the same casting temperature and outer temperature as above.

### *Freezing of concrete*

HPC has considerable potential for eliminating the risk of early freezing of concrete that otherwise may lead to serious damages on the concrete structure. The calculations show that there is no frost damage risk for a K70 concrete without use of any winter protection methods, compared to a K30 concrete that needs both covering and insulation of the concrete for the same conditions (outer air temperature of -10°C and concrete temperature of 25°C at casting).

### *Concrete temperature at casting*

There is a significant effect on the strength development during winter conditions by the temperature of concrete at casting. For instance, an increase from 20°C to 25°C leads to that a K70 concrete does not need the use of any winter protection methods, in comparison with a starting temperature of 20°C, which requires covering to avoid early freezing damages.

## **Economical aspects**

The study shows that there are multi-interactions between different parameters affecting the concrete strength development. When summarising the results of the study, there is a potential for reducing the production costs by decreasing the required production time, both for summer and winter conditions when utilising the rapid strength development of HPC. However, the study does not aim at making a detailed assessment of the difference between HPC and NPC considering added materials costs and reduced production costs. The interaction between these costs is complex and also to a large extent dependent on specific conditions of various building projects. Therefore, only a brief description of the potential based on the result of the study is presented below.

- For summer conditions, utilisation of HPC instead of NPC includes a potential for reducing the production time through early stripping of formwork and/or early tensioning of post-tensioned reinforcement
- During winter conditions, HPC significantly reduces the production time by the same reasons as for summer conditions mentioned above, but also through the potential for reducing or eliminating the added costs connected to external winter protection concrete methods, which may be needed for early stripping of formwork in order to avoid early freezing of concrete

When discussing economical aspects it is also important to consider practical matters. With the aim of reducing the building costs during wintertime, it is important to predict the climate conditions during production in order to optimise the concrete quality (strength level) in relation to required external winter protection concrete methods. For example missing parts of external protection methods can lead to local freezing damage. It can also be time-consuming, expensive and create logistical problems if necessary changes have to be made of the planned methods, due to unexpected difference in surrounding air temperatures in relation to the predicted. However, a HPC of which the rapid heat and strength growth are utilised probably is also the most flexible and safe solution regarding unexpected problems and hard-predictable factors such as unexpectedly low outer temperature after casting. A large increase of the concrete quality, with the aim of only reducing the strength development time when winter casting, may however lead to economical sub-optimisation. In a more detailed economical analysis of the benefit of using HPC, consideration should be taken also to other aspects, as for instance shorter drying time and possibilities for improved structural design.

## **4.2 Utilisation of SCC for more rational production**

SCC is claimed to be one of the most innovative developments in concrete materials technology. By utilisation of SCC, the traditionally required vibration work for compacting ordinary concrete can be *eliminated*. Due to this opportunity, a wide range of benefits within concrete cast in-situ production is created. This section concentrates on the two main beneficial areas work environment and increased productivity.

### **4.2.1 Work-environmental aspects**

Traditional in-situ cast concrete is criticised for causing work-environmental disadvantages due to the required vibration work. Concrete vibrators may lead to vibration injuries on concrete workers. Besides, it might cause heavy work and/or hearing impairment. Another aspect is the decreased safety on site due to high noise levels of the concrete vibrators. However, SCC may be a solution to these problems that are further described below. In Sweden today there are no demands coupled to health aspects related to vibration work of concrete. Whether these types of demands will be introduced, since SCC is available, is uncertain but discussed.

#### **4.2.1.1 Elimination of the “white fingers syndrome”**

Long-time use of hand-held concrete vibrators may cause injuries called “white fingers syndrome” or HAVS (Hand Arm Vibration Syndrome). A large percent of concrete workers are pre-retired due to this reason. Increased usage of SCC result in a reduced need for concrete vibrators on site and may affect the work-environment strongly in a positive way.

#### **4.2.1.2 Reduction of heavy work**

Another work-environmental disadvantage of normal concrete is that somewhat injurious working methods sometimes are required. Examples are heavy lifts and forced operating positions. SCC in combination with pumping creates opportunities for earlier working methods. The role of the concrete worker will merely be to control the casting process.

#### **4.2.1.3 Noise decrease**

By eliminating the concrete vibrators, the noise level on the building site may be significantly decreased. This is not only a question of reducing the risks for hearing impairment, but is also a potential for reducing the general safety risk. Lower noise level creates possibilities for easier communication on site during concrete casting. Perhaps the work environment will therefore be considered as more comfortable in general. Besides, people living or working close to the building site might probably appreciate quieter building sites.

## **4.2.2 Potential of SCC for more rational production methods**

The fact that SCC comprises the elimination of vibration may be seen not only as a possibility for improved work-environment, but also as a possibility for an increased competitiveness concerning production economy, compared to traditional concrete. Below, five potential benefits of SCC are exemplified with regard to production economy aspects.

### **4.2.2.1 Reduction of personnel**

There have been discussions whether SCC decreases the manpower requirement or not. The need for personnel obviously decreases with the fact that no vibration has to be done. But SCC may also lead to the need of more manpower for preparation of formwork (making this more strong and tight). It is clear that the possibility to reduce manpower to a large extent depends on the type of building project.

### **4.2.2.2 Reduction of finishing work**

A properly proportioned SCC may lead to smooth concrete surfaces with low amount of surface pores. Compared to an average concrete, this gives potential cost savings by reducing the often-needed finishing work of the concrete surfaces.

### **4.2.2.3 Increased productivity**

The two earlier mentioned aspects of SCC:s potential, personnel reduction and reduction of finishing work, affect the productivity indirectly. An additional but direct advantage is that SCC may increase the volume of cast concrete per time unit. Much of the time spent on vibration work for traditional concrete may through SCC be utilised for casting instead. However, this potential advantage is somewhat dependent on the type of construction. For instance, casting of wall structures may be time demanding also for SCC, due to the demand for slow rise of concrete level in order to avoid concrete separation, low-quality surfaces and high form pressure. Casting of horizontal structures, e.g. concrete slabs, is not as sensitive as vertical structures. However, it has turned out by practical experiences that SCC can be used with success both for vertical and horizontal structures but that vertical structures require more solid formwork.

### **4.2.2.4 Casting of advanced structures**

There are also the benefits of SCC with regard to the casting of advanced designed and geometrically complicated structures. For instance, in cases where the structures are densely reinforced, traditional concrete plus vibration work are very time demanding and nearly impossible to manage in practice. In these cases, SCC can be utilised as a competitive method and for some cases as the only possible solution in practice. One specific technical solution to advanced designed and vertical concrete structures (e.g. walls), is to pump SCC from below through special valves in the formwork and further letting the SCC automatically compact itself and fill the formwork.

#### **4.2.2.5 Economical aspects**

There is considerable economic potential of using SCC. In a long-time perspective, SCC may reduce presumptive future costs (for reparation etc) by increasing the structure durability through guaranteeing the quality of concrete compaction, e.g. compaction around reinforcement bars. There are also the aspects of future cost savings related to reduced health care for concrete workers.

In a shorter perspective, for SCC to be profitable considering the direct production cost, the production cost savings must be larger than the added direct materials costs of SCC.

However, potential cost savings by using SCC differs for different types of building projects and are therefore, in general, difficult to quantify. It is still today also common that the benefits of SCC for specific projects are discovered and utilised ad hoc during the execution of projects. Proper planning within the early stages of projects, where regard is taken to the total effects of SCC, is probably necessary for utilising the total economical potential of SCC.

## Chapter 5

### Building function related potential of new concrete materials technology

#### 5.1 Increased flexibility/future refurbishment by utilisation of HPC

Structural frames produced of average concrete and designed as solid slab/wall structures often limit the flexibility for future changes and adaptation to new use of the building. The low bearing capacity of average house-building concrete reduces the maximum allowed slab spans. Bearing walls of solid concrete, limits the possibilities for future refurbishment in comparison with slab/column structures including easily dismantlable walls. Chapter 3 “Structural potential of HPC within house building” indicates possibilities for increased flexibility, such as increased possibilities for the user to change the function of the rooms to meet future requirements. Increased floor spans and/or dismantling or mounting of light walls create possibilities not only for further arranging of furniture but also for new functions of the rooms. To meet the presumptive increased requirements for working at home in the future, residential functions more frequently have to be rebuilt into office functions.

Below, Figure 5.1 illustrates the potential of HPC and slab/column structures for increased flexibility. “A” illustrates a solid concrete slab/wall structure of NPC and “B” of HPC. The span is significantly increased for “B” but future requirements for refurbishment is however limited compared to “C” and “D”, which illustrate slab/wall structure supported by column, including two alternatives for placing the internal dismantlable walls. Another possibility is to use bigger slab/column structures with large span between the columns.

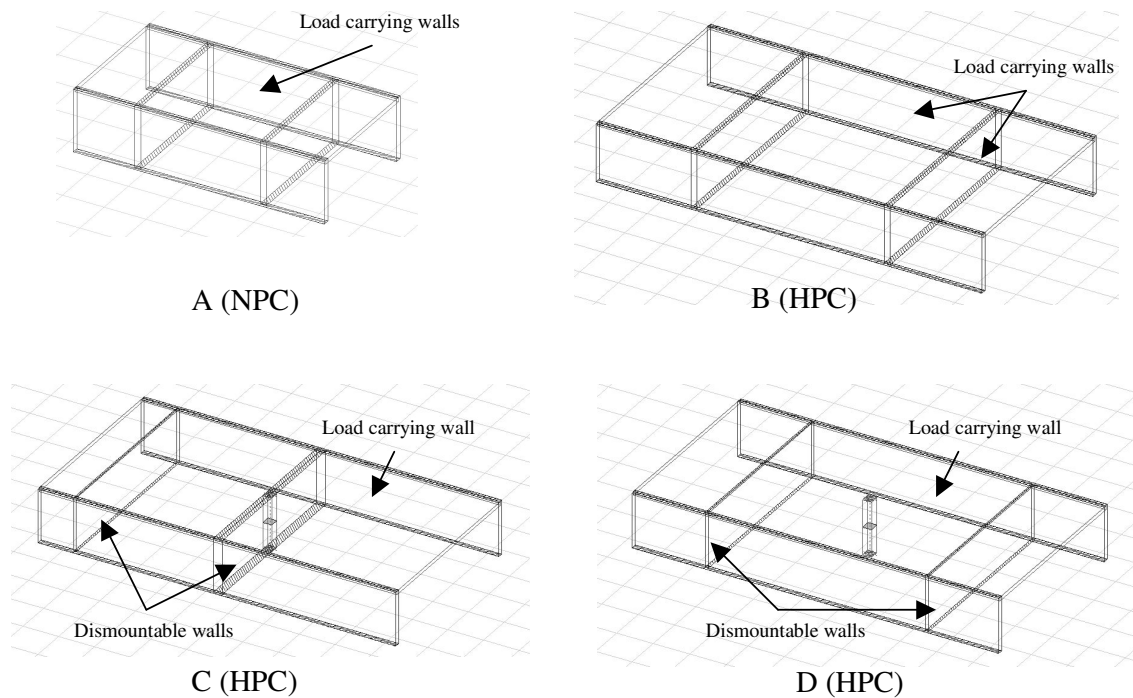

Figure 5.1 Examples of increased flexibility regarding future refurbishment by the use of HPC.

## 5.2 Reduced moisture problems by utilisation of HPC

Insufficiently dried concrete may indirectly contribute to moisture related health problems in the finished building, the so called “sick building syndrome”. The reason is that organic flooring material or other organic materials in contact with moist alkaline concrete emits unpleasant gases to the room. These are measured as VOC (volume of organic compounds) or TVOC (total volume of organic compounds). The concrete itself has negligible emission, even when regard is taken to chemical additives. Another problem is mould growth, which may occur if concrete with high moisture content is in direct contact with wood or other organic materials. Therefore it is important to dry out concrete before sensitive materials are placed in contact with it. Generally accepted values in Sweden on the maximum concrete humidity with regard to various floor-covering materials are presented in Table 5.1 below.

*Table 5.1 Allowed maximum levels of concrete relative humidity (RH) according to Swedish rules, measured on the equivalent depth, for different type of floor-covering materials.*

| <b>Materials</b>             | <b>RH requirements (%)</b> |
|------------------------------|----------------------------|
| Textile                      | ≤ 90%                      |
| Cork                         | ≤ 85%                      |
| Linoleum                     | ≤ 90%                      |
| Rubber                       | ≤ 85%                      |
| PVC (> 50% filling material) | ≤ 90%                      |
| PVC (≤ 50% filling material) | ≤ 85%                      |

To reach a relative humidity of 90%, an average house-building concrete needs approximately 6 months, which in the worst case may extend the total production time by the same time. For RH levels of 85%, the required drying time can be nearly impossible to manage in practice. If permanent steel formwork and no controlled drying are used, drying times of over 20 months are often required. However, if HPC with low w/c ratios and self-desiccation, is utilised instead of NPC, the required drying time can be significantly reduced. RH levels of 85% are then possible to reach within a couple of months. Local moisture problems related to various dimensions of the constructions are also easier to avoid if HPC is used, since the self-desiccation effect makes the drying time of HPC nearly independent of the construction thickness. See Chapter 4.1.

There are ongoing discussions on whether HPC, because of its' dense structure, may cause emissions due to the smaller permeability. Also a pre-dried HPC has to absorb water from water-based adhesives used for bonding flooring materials. This effect, together with the high alkali content of HPC, are claimed to lead to increased emissions from the floor adhesives. As a preventing method, alkali-resistant screeds can be used.

## 5.3 Increased acoustic quality by utilisation of HPC

Concrete structural frames normally result in high levels of acoustic insulation. There are two main types of sound transmission within a building, (1) impact sound caused by impact (like steps) directly on the concrete and (2) airborne sound (talk or music) transmitted from air to the building frame. Airborne sound can be transmitted in two ways, through direct transmission (directly crossing a slab or wall) or flank transmission (crossing via connected walls or slabs). One of the most significant affecting parameter on the acoustic quality is the



concrete thickness, especially for isolation against low frequency sound. However, there are many other factors affecting the sound insulation, e.g. the type of structural frame, partial wall properties, installation systems, floor covering materials and proportions of the rooms.

According to the Swedish building regulations (Boverket, 1999), there are four recommended acoustic quality classes; A (the highest class), B, C and D, of which C is the minimum required for production of new house-buildings (D is required for renovation projects). The classes are set with regard to two types of acoustic aspects, airborne sound insulation and impact sound level.

For concrete slabs, a thickness of approximately 0,28 m is required for Class A and 0,22 m for B, with regard to vertical airborne sound insulation. Regarding impact sound level, the required concrete slab thickness for the two acoustic classes is approximately 0,25 and 0,19 m.

An obstacle for utilising the high sound insulation properties of concrete structural frames has been the extended drying time for increased thickness of concrete constructions. Reaching high-quality sound insulation has generally been impossible if short production times are required and conventional house-building concrete is used. But if HPC with low w/c ratio is used, the effects of self-desiccation can be utilised, which gives reduced drying time, even for concrete members with big thickness, see the figures 5.2 a and b below. The result is based on the calculations of required drying times made in Chapter 4 “Production related potential for new concrete materials technology”. Constant parameters for the calculations are formwork of permanent steel and the climate condition (18°C, 60% RH) from the start of casting. In HPC (w/c ratio of 0,35) a silica fume content of 5% is used.

**Required drying time (months)**

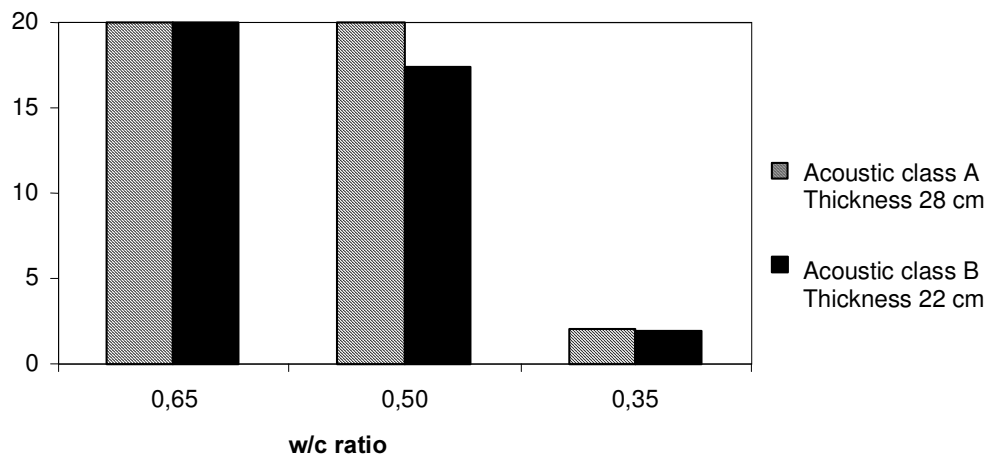

*a*

### Required drying time (months)

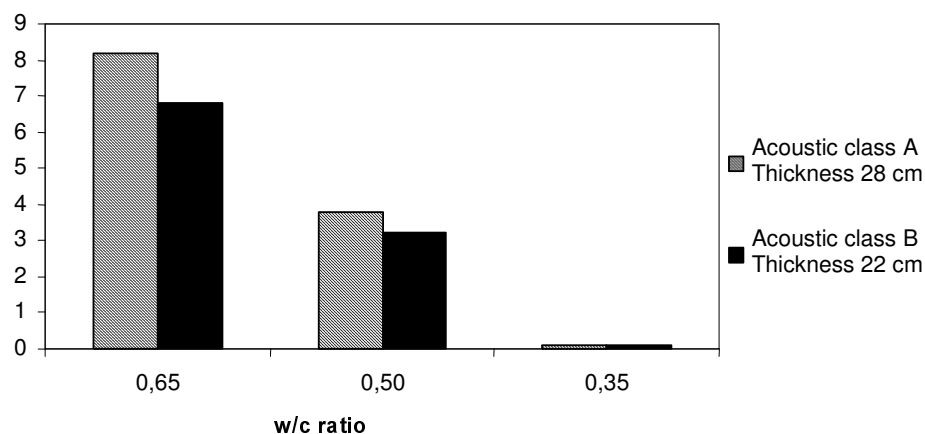

b

Figure 5.2 Drying times for various concrete qualities according to the result of the production study in Chapter 4, recalculated with regard to acoustic classes according to the Swedish Building norm. Figure “a” presents the required drying time for reaching 85% RH and “b” for reaching 90% RH, with regard to criteria for acoustic sound class A versus B.

According to Figure 5.2, when HPC is utilised, high acoustic quality is possible to manage even if short production time is required.

## 5.4 Decreased energy-consumption by utilisation of HPC

Many studies of the energy consumption related to house-buildings, indicate that approximately 85% of the total energy consumption is connected to the usage phase and only 15% to materials production, building erection, renovation, demolition etc. (Adalberth, 2000). In Sweden, the energy consumption related to the building sector is about 40% of the total energy consumption in Sweden. The concrete house-building sector is sometimes criticised for being more energy demanding than competing materials for the building of structural frames, such as wood or steel, but considering the entire life cycle, concrete is probably not more energy demanding than other materials.

The major advantage of concrete structural frames, when it comes to indoor thermal comfort, is the high weight. A structural frame of concrete is able to buffer and store heat to larger extent than wooden or light building structural frame systems, depending on the high heat capacity. As a result, the heat capacity of concrete affects both the indoor air quality and the costs during the total usage phase. One important prerequisite though, is that day-related variations of the indoor air temperature can be accepted by the resident and tolerated by the heating and ventilation system. Otherwise, the opportunity for buffering heat within the concrete construction will be eliminated.

The thickness of the concrete structural frame is important not only for acoustic aspects, but also for the thermal aspects. The thickness of a concrete wall has to be at least 10 to 15 cm for having maximum capacity of storing heat. An even thicker wall does not increase the capacity. Because of the extended production time associated with increased concrete thickness using ordinary house-building concrete, there is a potential for HPC also with regard to thermal aspects. When summarising the life cycle heating and cooling costs for house buildings, the added materials costs for HPC may be easier defended.

## Chapter 6

### Obstacles for the implementation of new concrete materials technology

#### 6.1 Technical obstacles

##### 6.1.1 Technical obstacles for the implementation of HPC

Technical obstacles for the implementation of cast in-situ HPC relate to difficulties in production of ready-mix concrete, to technical performance problems of the fresh and hardening concrete on site and to uncertainties in the function of the hardened concrete. Below, the main issues regarding technical obstacles and uncertainties for the implementation of HPC within house building are briefly presented. Note that many technical barriers have been managed by means of solutions based on research.

###### 6.1.1.1 Technical obstacles related to the ready-mix concrete production

Generally, the requirements are higher for all ingredients used in HPC, compared to NPC. Increased control of properties and variations in ingredients, as well as proper mix proportioning is necessary to achieve the desired performance.

- Mix proportions (Petersons and Åberg, 2000)  
Mix proportioning of HPC is more complicated than for NPC, because of the contradicting requirements for good workability and low amount of water. Often, these parameters have to be compromised and balanced to create an acceptable level of the workability in relation to the low water content. Compared to NPC, HPC is significantly more dependent on proper mix proportioning where regard is taken to all included sub materials, to achieve the desired performance. As for instance, the strength of the cement paste determines the strength of NPC. For HPC though, all ingredients (as cement and aggregate) and the interaction between these (as the interface between cement paste and aggregate) strongly influence the strength of HPC. Mix proportioning of HPC can be summarised as a process that requires increased control of the quality of ingredients as well as controlling the amount of all ingredients.
- Cement (Sandberg, 2000a)  
For HPC used for civil engineering constructions, coarse-ground, sulphate resistant and low alkali cement is normally used in order to achieve low heat development (to avoid cracks), high final strength and low water need. The latter increases the workability of HPC and further makes the mix less sensitive to variations in ingredients. However, within house building, the requirements often include fast strength development and rapid drying. Therefore fine-ground cement is often used. This cement type often has higher alkali content, which increases the need for mixing water, and also affects the workability in a negative way. This can however be balanced by means of water reducing additives.

- Additives (Sandberg, 2000b)  
Super plasticisers, water reducers and air entrainment are the main types of additives for HPC. Super plasticisers are always required for managing the low w/c ratio of HPC, but the content must be limited in order to avoid retarded hydration, concrete separation and plastic cracking. There are also risks for increased air content when water reducers are used. This will decrease the strength of the concrete. Often, strength is no problem. Then the use of air entrainment may affect HPC positively by increasing the workability.
- Pozzolans (Sandberg, 2000a)  
HPC including silica fume affects the stability and strength in a positive way. Further, within house building, silica fume is often added with the aim of increasing the self-desiccation effect and reducing the drying time. The amount of silica fume in HPC is set to 5% of the cement content in order to limit the increased stickiness of the fresh concrete caused by silica fume.
- Aggregates (Fagerlund, 2000)  
For HPC, the type, amount and gradation of aggregate significantly affect the workability of the fresh concrete as well as the performance of the hardened concrete. Therefore it is even more important to control and test the effects of aggregate on HPC even regarding small variations in aggregate properties.  
The cement paste in HPC is very strong. Therefore the aggregate can be the weak link if precautions are not taken to avoid inferior aggregate. Also other properties of HPC (E-modulus, tensile strength) are to a high degree dependent on the properties of the aggregate. By selecting suitable aggregate, the stiffness and tensile strength can be increased above normal values. This is very important for efficient use of HPC as structural material, see Chapter 3.  
The control of the performance of aggregates is for that reason also important regarding the hardened concrete. Unusually high quality aggregate may be required, which can be problematic since such aggregate (like diabase) is scarce.

#### **6.1.1.2 Technical obstacles related to the fresh concrete on site**

- Casting conditions, e.g. workability (Byfors, 2000 and Nykvist, 2000)  
The increased cement content and decreased water content of HPC (the low w/c ratio), together with silica fume, may make the concrete “sticky”, due to the increased cohesion. This might cause trouble with compaction and with finishing of surfaces. Special attention should also be paid to the more rapid stiffening (e.g. slump loss) of HPC. One positive effect of casting HPC is the reduced risk for concrete separation, which depends on the decreased water content and increased fines content. An open dialogue between the concrete supplier and the contractor is recommended on information about workability, vibration efforts etc.

### 6.1.1.3 Technical obstacles related to the function of the hardened concrete

- Cracking (Emborg, 2000)  
Due to the high cement content of HPC, the risks for temperature cracks increase. Also, the plastic and autogenous shrinkage in HPC may lead to increased risk of early cracking of HPC structures.  
As with NPC, it is also for HPC recommended to limit the early heat development of the concrete structure, in order to reduce the temperature difference within the structure and between the structure and surrounding structures or rock.
- Emission (Nilsson et. al., 2000)  
The dense structure of concrete surfaces in combination with the increased alkali content of HPC might lead to potentially increased risks for emissions from water-based adhesives and flooring materials. It is not known though if this possible risk is real or not. The possible problems might be avoided by using alkali-resistant adhesives and low-emitting flooring materials.
- Fire resistance (Anderberg, 2000)  
Due to the dense structure of HPC, the possibilities for vapour and moisture transport are limited. In the case of fire, high vapour pressures may appear, which may lead to risks of surface spalling of HPC. The interaction between affecting parameters is complex. To prevent from surface spalling, polypropen fibres can be added. In the case of fire, the fibres will melt and create a fine pore system, which reduces the vapour pressure and thereby decreases or eliminates the risk for surface spalling.

### 6.1.2 Technical obstacles for the implementation of SCC

In comparison to ordinary concrete, SCC requires extended control of the mix proportions as well as the concrete casting conditions. Small differences in mix proportions or in in-situ conditions can result in a number of technical quality problems, which are described in the section 6.1.2.1. There are also the impediments for increased utilisation addressing the lack of knowledge of certain properties of hardened SCC (e.g. fire resistance, creep and shrinkage), see further the section 6.1.2.2.

#### 6.1.2.1 Technical obstacles due to production difficulties

##### Mix-proportioning

As mentioned, SCC is, compared to normal concrete, significantly more sensitive to variations in the mix proportions and production conditions. Small differences in quality and amount of filler, water, cement, aggregate and additives may for example lead to concrete segregation and early loss of self-compacting ability. If the SCC-mix is not properly balanced there are risks for problems on site. Therefore increased control of SCC is required, both at the ready-mix concrete factory and on site. Also, incorrect handling of the fresh concrete, for instance when transporting or casting, may lead to negative results as described below.

## **Production problems**

- **Robustness of the mix**  
The self-compacting properties may easily be lost during transport and handling of the concrete, especially when there is long time between mixing and casting. As a result there might be insufficient compaction and enclosure of reinforcement bars. It is important to develop mixes that are robust so that these problems do not occur.
- **Pores in the concrete surface**  
One of the main benefits of SCC is the high quality of the concrete surface, which reduces the expensive costs for finishing work. However, there are several factors that may affect the quality of the concrete surface in a negative way. If the rise of the concrete front is too fast, air content in concrete may not be released properly, which may cause an unacceptably porous concrete surface.
- **Cracking**  
SCC may lead to cracking due to increased plastic shrinkage when high filler contents are used.
- **Transportation**  
Compared to normal concrete, SCC is more sensitive to variations in transport. During long transport the self-compacting ability may be impaired or lost, especially when the mix contains big amount of super-plasticiser. One solution to this problem is to add some of the admixture at the building site. This requires the use of truck mixing.
- **Pumping**  
SCC is normally well suited for pumping, but at high pump pressure, there may be problems with slump loss and/or decrease of air content.
- **Formwork**  
The form pressure of SCC might be considerably higher than that of normal concrete. Therefore, stronger formwork will normally be needed for vertical structures (walls, columns).

### **6.1.2.2 Technical obstacles due to lack of knowledge**

Even though there has been intense research on SCC during the 1990s, there are still areas where knowledge is partly lacking. In particular, the effects of the high filler content of SCC need further research. It is often observed that the strength is increased for SCC with increased content of limestone filler, even at constant w/c ratio. The reasons may be physical effects, as for instance improved microstructure and/or chemical effects, e.g. chemical reaction between cement components and filler, which may lead to more dense structure. Below, the most relevant areas for further research of SCC with regard to house building are presented briefly:

- **Plastic shrinkage and drying shrinkage**  
The research and the experience of shrinkage of SCC are contradicting. The high filler content of SCC may lead to increased plastic shrinkage due to early drying. The effect of type of filler is however not clarified. The drying shrinkage ought to be somewhat

higher for SCC due to the high filler content. No systematic studies on the issue comparing SCC with normal concrete seem to have been performed.

- **Form pressure**  
The form pressure of SCC is assumed to be related to the type of SCC, mix-proportions and tixotropy. Another effect on the form pressure is the rate of the rise of the concrete level. Higher speed leads to increased form pressure. The relation between form pressure, rate of casting and rheological properties of the fresh SCC has to be investigated.
- **Drying time**  
Compared to normal concrete, SCC leads to a higher strength for the same w/c ratios due to the filler effect. This may cause longer drying times for SCC than for normal concrete with the same strength. The fact that lower cement content can be used, also contributes to a reduced self-desiccation effect.
- **Concrete performance during winter conditions**  
The lower cement content in SCC at a given strength level may, during low surrounding temperatures, lead to lower degree of heat development and slower strength development, in comparison with normal concrete. This can be easily compensated for, by increasing the strength of the concrete.
- **Fire-resistance**  
SCC with high filler content (lime stone) seems to increase the risk of spalling during fire, (Persson, 2003). Though, this problem has to be studied more before any safe conclusion can be drawn. The problem can be handled by mixing polymer fibers in the concrete.

## **6.2 Obstacles related to the building process**

### **6.2.1 Organisation**

Like other innovations to be implemented within the building sector, the introduction of new concrete materials technologies meets barriers related to how the building sector is organised. Below, the most significant barriers are presented, of which the two latter are connected to new concrete materials technology and not to innovation in general.

- Conservatism among the actors
- Lack of knowledge and low interest for innovation
- Missing information-spread and feed-back between and within the actors
- Unclear responsibility  
(Example: It is not always clear who is responsible for compaction of SCC. Is it the ready-mix producer delivering the mix or the constructor casting the mix? When problems with compaction occur, the responsibility of the two participants might be a matter of controversy.

- Risks for concrete workers losing their jobs due to less need for personnel when utilising SCC

### **6.2.2 Economy**

Often, the economical issues within house building are focused on production economy and not on the whole life cycle of buildings. To predict future costs and benefits in comparison to other materials can be difficult. Some factors are also hard to quantify in economical terms, as in the case of different types of quality of (serviceability, functionality, aesthetics etc.). However, such factors are seldom affected by the choice of materials in the structural frame. Another aspect is that the multi-benefits of new materials technologies are seldom analysed. When discussing new materials technology, it is common that the discussion addresses one single production economical benefit, which may lead to sub-optimisation. The full range of the potential of new technology is therefore seldom utilised.

Another aspect of the economical barriers for new concrete materials technology is that of the direct costs. Often the supplier of concrete set a higher price level for new concrete types, compared to the direct materials costs and ready-mix concrete production costs. The reasons are often the increased risk for failure, which is connected to the low amounts of delivered new concrete technology. With SCC, the set price is also affected by the increased responsibility for the supplier due to the elimination of traditional vibration work that for normal concrete has been included within the responsibility of the contractor. As for HPC, the increased concrete quality often requires extra tests on site, which leads to added costs. Below the discussed economical barriers are summarised:

- Economy questions often focused on direct materials costs and not the total production cost or the total life cycle for buildings
- Sub-optimisation (regard is seldom taken to multi-benefits)
- Pricing of HPC (product cost criticised for being set too high if regard is taken to the real materials costs)
- Pricing of SCC (price of SCC criticised for being set too high compared to real materials costs)
- Added costs (due to presumptive extra required testing of HPC and SCC)

### **6.2.3 Building codes**

The Swedish building code BBK 94 (Boverket, 1994) includes concrete qualities with a maximum cube compression strength of 80 MPa (K80). If higher levels of the concrete strength class are to be used, special investigations have to be conducted. However, the new Swedish HPC Design Handbook (Swedish Building Centre, 2000b) treats strength classes up to 120 MPa.

In the planning phase of building projects, the norms might discourage from use of HPC, due to presumptive added costs for concrete testing and/or uncertainties regarding risks for



technical problems. International codes differ regarding the maximum allowed strength level. See further Table 6.1 below (FIP/CEB, 1994). Building codes have therefore been criticised for not being updated with regard to novel concrete materials. For example, the Swedish building regulations stipulate specific design values not only for compression strength, but also for tensile strength and elastic modulus (E-modulus). The latter two are both coupled to the compression strength class. These values are based on standard values addressing the correlation between testing on concrete cubes or cylinders and not the finished construction. If higher levels of tensile strength and E-modulus are to be utilised, special investigations have to be conducted.

*Table 6.1 Examples of various international codes, which cover HPC according to FIP/CEB (1994).*

| <b>Country</b>     | <b>Building code</b>                | <b>Max. comp. strength (MPa)</b> | <b>Test specimen</b>    |
|--------------------|-------------------------------------|----------------------------------|-------------------------|
| Sweden             | BBK 94                              | 80                               | Dry cube 150 mm         |
| Sweden             | HPC Design Handbook                 | 120                              | Dry cube 150 mm         |
| International      | CEB-FIP MC-90                       | 80                               | Wet cylinder 150/300mm  |
| International ext. | CEB-FIP MC-90                       | 100                              | Wet cylinder 150/300mm  |
| US                 | ACI 318-89                          | no maximum specified             | Wet cylinder 152/304 mm |
| Germany            | Suppl. to DIN 1045,<br>488 and 1055 | 115                              | Dry cube 200mm          |
| Norway             | NS 3473                             | 105                              | Dry cube 100 mm         |
|                    |                                     | 94                               | Wet cylinder 150/300 mm |
| Japan              | Specification for HPC               | 80                               | Wet cylinder 100/200    |

Contrary to HPC, SCC is within the Swedish building regulations today not separated from normal concrete. Therefore the codes are not seen as barriers for SCC. However, the strength class of SCC due to the filler-effect often automatically increases, even though the same w/c ratio and amount of cement are used. This fact may for instance lead to requirements for increased amounts of reinforcement, which in turn itself can be an obstacle.

# Chapter 7

## Conclusions

Conclusions from the study are presented below. They are divided under three headings:

1. Possibilities
2. Obstacles
3. Future research

### 1. Possibilities

#### Structural design (HPC)

The structural analyses show that utilisation of HPC with increased concrete tensile strength (to 5,0 MPa) and/or increased elastic modulus (to 50 GPa), will lead to the following possibilities:

- Increased slab spans by approximately 40% for slab/wall structures (with regard to reduced deflection in the serviceability limit state) and approximately 50% for slab/column structures (with regard to reduced risk for punching in the ultimate limit state).
- Decreased slab thickness or decreased amount of reinforcement as an alternative to increase of the slab spans.

Increased compression strength itself does according to the studies not affect the opportunities for increasing the slab spans to any significant extent, unless exceptionally large amount of reinforcement is used.

Reinforcement in a slab can be designed according to two main principles:

1. Based on the maximum moment in field or over support
2. Based on the actual moment curve

The study shows that the following reduction of reinforcement can be made if principle 2 is used:

- 25 - 80% for slab/wall structures
- 50 - 80% for slab/column structures

#### Structural design (SCC)

There are some structural design related benefits of SCC (only briefly described within the project), addressing the ability for casting advanced concrete constructions with dense reinforcement through elimination of the vibration work.

## **Production (HPC)**

The analysis performed in the project shows that potential production related benefits of HPC are as follows:

- The required drying time for reaching 85 and 90% RH on the equivalent depth in concrete slabs is significantly reduced in HPC with low w/c-ratio, especially when silica fume is included. In comparison with normal house-building concrete, the use of HPC during summer conditions can, for instance cause a reduction from 16 months to less than 2 months to reach RH 85%. For cold surrounding air temperatures though, the study indicates the importance of achieving rapid concrete temperature development also in HPC during the first days after casting, in order to utilise the significant self-desiccation effect and thereby enable rapid drying.
- The results of the study indicate significantly faster strength development of HPC compared to NPC, especially during cold surrounding air temperatures. This creates beneficial potential for earlier formwork skipping, earlier post-tensioning of reinforcement and reduction of the risks of early concrete freezing. Another aspect of the result is the ability for eliminating or reducing the requirements for external winter concrete methods (e.g. insulating, covering and heating of the concrete) for HPC compared to NPC.

## **Production (SCC)**

The potential of SCC addresses, by the elimination of vibration work, the following aspects:

- Improved work environment (eliminated risk for vibration injuries, less heavy work and reduced risk for hearing impairment)
- Higher safety (decreased noise levels on site creates opportunities for easier communication)
- Reduced need for manpower (during concrete casting, less personnel is required)
- Increased productivity (e.g. larger amounts of concrete may be cast per time unit with the same efforts)
- Less finishing work (utilising potential high-quality concrete surfaces)

## **Building function**

The presumptive benefits of HPC:s effects on building function are described below. They can be seen as synergy effects of the positive effects on structural design and production:

- Increased flexibility in future refurbishment (based on increased slab spans in combination with dismountable inner walls)

- Improved indoor environment (due to less moisture problems according to faster drying)
- Increased acoustic quality (addressing the opportunity for building heavier, and thereby also more sound insulating concrete structures without any extended drying/production time)
- Reduced energy consumption (addressing the opportunity for building heavier, and thereby also more heat buffering concrete structures without any extended drying/production times)

## **2. Obstacles**

### **Technical obstacles**

The study describes technical obstacles, including proposals for solutions, for the implementation of HPC and SCC within house building. Below, the main obstacles are listed together with examples of specific problems:

#### **HPC**

- Problems related to the ready-mix concrete production process (more complex mix design, increased control of quality of ingredients etc)
- Problems related to handling of fresh concrete on site (low workability)
- Problems related to the function of the hardened concrete (increased tendency for cracking, increased risk of emissions from adjacent materials, decreased fire resistance)

#### **SCC**

- Problems related to production
  - Mix design (sensitive to small changes in mix, increased quality control of ingredients needed)
  - In-situ production (loss of self-compaction, increased risk of plastic shrinkage, increased form pressure)
- Problems caused by lack of knowledge (interrelations between mix composition and rheological properties, form pressure, mechanical properties of hardened concrete)

## **Building process related obstacles**

Such obstacles are related to:

- Organisation (improper co-operation between actors, lack of competence and interest concerning novel technology, tradition related decision criteria for the choice of materials etc)
- Economy (sub optimisation – materials costs versus *direct* economical benefits, pricing of new concrete materials technologies etc)
- Building codes (e.g. limitations and requirements for added controlling)

## **3. Future research**

Future research ought to focus on the following issues:

1. Field studies comparing HPC and SCC with normal concrete with regard to economy, productivity, work environment and indoor environment, drying, and quality of the finished structure. The field studies ought to be conducted for different types of structure and at different climate, summer and winter.
2. Further and deeper analyses of obstacles, technical and others, for implementation of HPC and SCC. The main focus should be on SCC since this is a material with extraordinary big potential.
3. Further analyses of the advantages of HPC for the function of the building.
4. Experimental work, in order to identify technical problems related to SCC and to give advice, as to how to avoid these problems.

## References

- Adalberth, K. (2000), Energy Use and Environmental Impact of new Residential Buildings, *Report TVBH-1012*, Lund: University of Lund, Dep. Of Building Physics.
- Anderberg, Y. (2000), Chapter 16 Fire, *Handbook of High Performance Concrete*, Stockholm: AB Svensk Byggtjänst (in Swedish).
- BKD, Byggekostnadsdelegationen (The Swedish Building Cost Commission) (2000), *Betänkande från Byggekostnadsdelegationen, SOU 2000:44*, Stockholm (in Swedish).
- Boverket (1999), *Boverkets Byggregler*, Karlskrona: The Swedish Board of Housing, Building and Planning (in Swedish).
- Boverket (1994), *BBK 94 Boverkets Handbok om Betongkonstruktioner*, Karlskrona: The Swedish Board of Housing, Building and Planning (in Swedish).
- Byfors, J. (1999), SCC is an important step towards industrialisation of the building industry, *Proceedings of the First International RILEM Symposium on Self-compacting Concrete*, Stockholm: RILEM Publications S.A.R.L, pp.15-21.
- Byfors, J. (2000), Chapter 6 Fresh concrete, *Handbook of High Performance Concrete*, Stockholm: AB Svensk Byggtjänst (in Swedish).
- Chen, Z. & Wang, D. (1996), Utilization of high-strength concrete in China, *Proceedings from the Fourth International Symposium on Utilization of High Strength/High Performance concrete*, Paris: Presses de l'ENPC, pp.1571-1580.
- Chew, M.Y. (1993), Utilisation of high strength concrete in Singapore, *Proceedings of the Third International Symposium on Utilization of High-Strength Concrete*, Lillehammer: Norwegian Concrete Association, pp.678-690.
- Claesson, C. (1999), *Praktisk tillämpning av högpresterande betong*, Göteborg: Byggmästareföreningen Väst/FoU-Väst (in Swedish).
- Elfgrén, L., Fagerlund, G. & Skarendahl, Å. (1994), Swedish R&D Program on High-Performance Concrete, *Proceedings of the International Workshop on High Performance Concrete in Bangkok*, Michigan: American Concrete Institute, pp.247-262.
- Emborg, M. (2002) Framtida forskning och samverkan, *CBI:s Informationsdag 2002 – Sammanfattningar*, Stockholm: Cement- och Betonginstitutet, pp.45-49 (in Swedish).
- Emborg, M. (2000), Chapter 7 Young concrete, *Handbook of High Performance Concrete*, Stockholm: AB Svensk Byggtjänst (in Swedish).
- Emborg, M. (2000), Chapter 12, Temperature and moisture influenced stresses and cracking, *Handbook of High Performance Concrete*, Stockholm: AB Svensk Byggtjänst (in Swedish).
- Fagerlund, G. (1980), Influence of slag cement on the frost resistance of concrete- a theoretical analysis. *Research Fo 1:80*. Stockholm: Swedish Cement and Concrete Research Institute.
- Fagerlund, G., Gillberg, B., Jönsson, Å. & Tillman, A-M. (1999), *Betong och Miljö*, Stockholm: AB Svensk Byggtjänst, pp.14-48 (in Swedish).

- Fagerlund, G. (1994), Chapter 28 High performance concrete, *Handbook of concrete- Materials*, Stockholm: AB Svensk Byggtjänst (in Swedish)
- Fagerlund, G. (2000), Chapter 4 Aggregate, *Handbook of High Performance Concrete*, Stockholm: AB Svensk Byggtjänst (in Swedish).
- FEM- Design Plate 3.50, (2000), PC-based computer program, Malmö: Skanska IT Solutions.
- Fundia Armering AB (2002), The BAMTEC-system, Photo taken by Fundia.
- FIP/CEB (1994), Application of High Performance Concrete, *Bulletin d'Information 222*, Lausanne: CEB
- Grauers, M. (1999), Self compacting concrete – industrialised site cast concrete, *Proceedings of the First International RILEM Symposium on Self-compacting Concrete*, Stockholm: RILEM Publications S.A.R.L, pp.651-658.
- Hallgren, M. (1993), *Use of high performance concrete in load bearing structures - Does high strength bring cost savings?* Stockholm: Royal Institute of Technology, Department of Structural Engineering.
- Hassanzadeh, M. (2000), Chapter 9 Strength, *Handbook of High Performance Concrete*, Stockholm: AB Svensk Byggtjänst (in Swedish).
- Hassanzadeh, M. (2000), Chapter 9 Strength, *Handbook of High Performance Concrete*, Stockholm: AB Svensk Byggtjänst (in Swedish).
- Hassanzadeh, M. (1998), *Brottseghet hos högpresterande betong*, Intern rapport M4:06, Lund: University of Lund, Dep. of Building materials (in Swedish).
- Hedenblad, G. (1996), *Fuktmätning I högpresterande betong*, Intern rapport M8:4, University of Lund, Dep. of Building materials, (in Swedish).
- Helland, S. (1996), Utilization of HPC, *Proceedings from the Fourth International Symposium on Utilization of High Strength/High Performance concrete*, Paris: Presses de l'ENPC, pp.67-73.
- Helland, S. (1999), Introduction of HSC/HPC in the market, A Contractors view, *Proceedings from the 5<sup>th</sup> International Symposium on Utilization of High Strength/High Performance Concrete*, Sandefjord: Norwegian Concrete Association, pp.14-17.
- Hett 97 (1997), PC-based computer program, Stockholm: SBUF, Cementa AB, NCC AB, Svenska Fabriksbetongföreningen.
- Hoff, G.C. (1993), Utilization of high strength concrete in North America, *Proceedings of the Third International Symposium on Utilization of High-Strength Concrete in Lillehammer*, Oslo: Norwegian Concrete Association, pp.28-36.
- Ikeda, S. (1993), Utilization of high strength concrete in Japan, *Proceedings of the Third International Symposium on Utilization of High-Strength Concrete in Lillehammer*, Oslo: Norwegian Concrete Association, pp.37-44.
- Jinnai, H., Namiki, S., Kuroha, K., Kawabata, I. & Hara, T. (1999), Construction and design of high-rise buildings using 100 MPa high strength concrete, *Proceedings from the 5<sup>th</sup> International Symposium on Utilization of High Strength/High Performance Concrete in Sandefjord*, Oslo: Norwegian Concrete Association, pp. 809-818.

- Ljunggren, S. (1995), Tysta huset klart för inflyttning, *Fastighetsnytt nr 16 1995*, Stockholm: Fastighetsnytt Förlags AB (in Swedish).
- Jonsereds Miljösystem AB (2002), Weather protection system "Torra Byggen", Photo taken by Jonsereds.
- Mängda (1999), *Marknadsanalys husbyggnad*, Stockholm: Mängda AB.
- Mizobuchi, T., Yanai, S., Takada, K., Sakata, N. & Nobuta Y. (1999), Field applications of self-compacting concrete with advantageous performances, *Proceedings of the First International RILEM Symposium on Self-compacting Concrete*. Stockholm: RILEM Publications S.A.R.L, pp.605-616.
- Nilsson, M. (1992), Chapter 8 Formwork for cast in-situ concrete, *Handbook of Concrete-Workmanship*, Solna: AB Svensk Byggtjänst (in Swedish).
- Nilsson, L-O, Hedenblad, G., Norling-Mjörnell, K. (2000), Chapter 11 Moisture properties, *Handbook of High Performance Concrete*, Stockholm: AB Svensk Byggtjänst (in Swedish).
- Nykvist, H. (2000), Chapter 20 Casting, *Handbook of High Performance Concrete*, Stockholm: AB Svensk Byggtjänst (in Swedish).
- Okamura, H. & Ouchi, M. (1999), Self-compacting concrete. Development, present use and future, *Proceedings of the First International RILEM Symposium on Self-compacting Concrete*, Stockholm: RILEM Publications S.A.R.L, pp.3-14.
- Ouchi, M. (1999), Self-compacting concrete development, applications and investigations, *Proceedings of the Nordic Concrete Research Meeting in Reykjavik*, Oslo: Norwegian Concrete Association, pp.29-34.
- Petersons, N., Åberg, L. (2000), Chapter 18 Proportioning, *Handbook of High Performance Concrete*, Stockholm: AB Svensk Byggtjänst (in Swedish).
- Persson, B. (2003), Self-compacting concrete at fire temperatures, *Report TVBM-3110*, Lund: University of Lund, Dep. of Building Materials.
- Persson, B. (1999), Modern betong och filigranform förutsättningar för ett rekordbygge I Malmö, *Reprint/Särtryck Sä 99.44*, Lund: University of Lund, Dep. of Building Materials (in Swedish).
- Persson, B. (1996), Långtidsdeformationer- grundkrypning hos högpresterande betong, *Intern rapport M06:14*, Lund: University of Lund, Dep. of Building materials (in Swedish).
- Persson, B. (1996), Betong anpassad för ett effektivt byggande, *Bygg & Teknik 7/96*. Stockholm: Förlags AB Bygg & Teknik (in Swedish).
- Persson, B. (1998), Self-desiccation and its' importance in concrete technology, *Nordic Concrete Research 21*, Oslo: Norwegian Concrete Association.
- Pichler, R. (1999), The use of SCC for building the Millennium Tower in Vienna, *Proceedings of the First International RILEM Symposium on Self-compacting Concrete*. Stockholm: RILEM Publications S.A.R.L, pp.729-732.



- Russel, H.G. & Fiorato, A.E. (1994), High-strength concrete research for buildings and bridges, *Proceedings of the International Workshop on High Performance Concrete in Bangkok*, Michigan: American Concrete Institute, pp.375-392.
- Sandberg, P. (2000a), Chapter 2 Cement and pozzolans, *Handbook of High Performance Concrete*, Stockholm: AB Svensk Byggtjänst (in Swedish).
- Sandberg, P. (2000b), Chapter 3 Additives, *Handbook of High Performance Concrete*, Stockholm: AB Svensk Byggtjänst (in Swedish).
- Skarendahl, Å. (2001), Market acceptance of self-compacting concrete, the Swedish experience, *Proceedings of the Second International Symposium on Self-Compacting Concrete in Tokyo*, Kochi: COMS Engineering Corporation, pp1-12.
- Swedish Building Centre (2000a), *Handbook of High Performance Concrete*, Stockholm: AB Svensk Byggtjänst (in Swedish).
- Swedish Building Centre (2000b), *High Performance Concrete Structures - Design Examples*, Stockholm: AB Svensk Byggtjänst (in Swedish).
- Swedish Building Centre (1990), *Handbook of Concrete – Design*, Solna: AB Svensk Byggtjänst (in Swedish).
- Swedish Concrete Association (2002), Självkompakterande betong- Rekommendationer för användning, *Betongrapport nr 10*, Stockholm: Swedish Concrete Association (in Swedish).
- TorkaS 1.0 (1998), PC-based computer program, Lund: University of Lund, Institution of Building Technology.
- Walraven, J. (1999), The future of high strength/high performance concrete, *Proceedings of the 5<sup>th</sup> International Symposium on Utilization of High Strength/High Performance Concrete in Sandefjord*, Oslo: Norwegian Concrete Association, pp.25-36.
- Walraven, J. (1993), High strength concrete: a material for the future? *Proceedings of the Third International Symposium on Utilization of High-Strength Concrete in Lillehammer*, Oslo: Norwegian Concrete Association, pp.17-27.
- Walraven, J. (2000), How can we shorten the bridge between design and material engineers, *Proceedings of the Nordic Concrete Research Meeting in Reykjavik*, Oslo: Norwegian Concrete Association, pp.1-3.
- Öberg, M. & Peterson, M. (2000), *Multi-dwelling concrete buildings in Sweden: a review of present technology, design criteria and decision making*, Lund: University of Lund, Department of Building Materials.

# **Appendix A**

## **Structural design study – background information**

- 1. Material properties**
- 2. Method of calculation – norms and equations**
  - 2.1. Ultimate limit state**
  - 2.2. Serviceability limit state**
- 3. Loads**

# 1. Materials properties

According to Swedish Building Centre (1990), chapter 2.3, the following data shall be used for concrete and reinforcing steel.

*Design concrete compression strength*

Ultimate limit state:

$$f_{cc} = f_{ck} / 1,5 \gamma_n \quad (\text{design compressive strength})$$

$$f_{ck} = 21,5 \text{ MPa for K30 and } f_{ck} = 56,5 \text{ MPa for K80} \quad (\text{characteristic compressive strength})$$

Design concrete tensile strength (if no investigation is performed)

Ultimate limit state:

$$f_{ct} = f_{ctk} / 1,5 \gamma_n \quad (\text{design tensile strength})$$

Serviceability limit state:

$$f_{ct} = f_{ctk} / 1,0$$

$$f_{ctk} = 1,6 \text{ MPa for K30 and } f_{ctk} = 2,65 \text{ MPa for K80} \quad (\text{characteristic tensile strength})$$

Design concrete elastic modulus (if no investigation is performed)

Ultimate limit state:

$$E_c = E_{ck} / 1,2 \gamma_n \quad (\text{design value})$$

Serviceability limit state:

$$E_c = E_{ck}$$

$$E_{ck} = 30 \text{ GPa for K30 and } E_{ck} = 38,5 \text{ GPa for K80} \quad (\text{characteristic value})$$

Design steel tensile strength (if no investigation is performed)

$$f_{st} = f_{yk} / 1,1 \gamma_n \quad (\text{design strength})$$

$$E_s = E_{sk} / 1,05 \gamma_n \quad (\text{design E-modulus})$$

$$E_{sk} = 200 \text{ GPa} \quad (\text{characteristic E-modulus})$$

$\gamma_n = 1,0$  for safety class 1 (low)

$\gamma_n = 1,1$  for safety class 2 (normal)

$\gamma_n = 1,2$  for safety class 3 (high)

## 2. Method of calculation – norms and equations (Swedish Building Code BBK94)

The calculations are performed by the PC-program FEM Design Plate 3.50. For more details concerning the below described method of solution, see FEM-Design Plate 3.50 Manual (2000).

### 2.1 Ultimate limit state

#### Main reinforcement

According to the Swedish building code BBK 94, the calculation of section forces for slabs may be based on elastic theory, BBK94 6.5.3.2. The design of the slab is performed with respect to the design moments described as follows:

The main applied moments, which have to be catered for by reinforcement, are the principal moments  $M_1$  and  $M_2$  and this is most economically done by placing the steel in these directions where steel with lowest cover is placed in the direction of maximum moment. However, as the directions of  $M_1$  and  $M_2$  vary from point to point and may, at a given point, have different directions for various load cases, it is more convenient to place the reinforcement in overall directions X and Y. When this is done, the components of the tensile resistance of the reinforcement in the directions of the principal tension must be sufficient to resist the principal tensile force. Reinforcement not placed in the principal directions are for this reason designed for a combination of bending- and twisting moments. The program calculates the design moments based on the theory for orthogonal reinforcement as described to include skew reinforcement.

$M_x'$   $M_y'$  = Design moments for reinforcement placed in overall directions X and Y.

$M_a'$  = Design moment for skew reinforcement placed an angle  $\alpha$  measured from the X axis.

At  $\alpha = 90^\circ$ ;  $M_a' = M_y'$

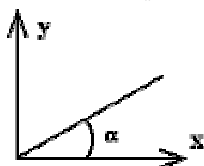

#### Design moments

FEM-calculated moments of the plate (according BHK 3.2:125 and BBK94 6.5.3.2)

Positive moments:

$$M_{xt} = m_x + \mu_1 * |t_x|$$

$$M_{yt} = m_y + 1/\mu_1 * |t_y|$$

Negative moments:

$$M_{xt} = m_x - \mu_2 * |t_x|$$

$$M_{yt} = m_y - 1/\mu_2 * |t_y|$$

where:

$m_x$  and  $m_y$  = bending moment in x- and y-direction

$t_x$  = torsion moment (according to BHK 6.5:33)

$\mu_1$  and  $\mu_2$  = positive number, dependent on practical issues (normally set close to 1)

#### Required bending reinforcement

In order to minimise cracking in the slab a good way is to reinforce according to the elastic moments which normally also leads to good reinforcement economy.

The required bending reinforcement is designed according to BHK 3.6:43 where a stress distribution according to BHK (figure 3.6:12b) has been assumed, see figure 1 below.

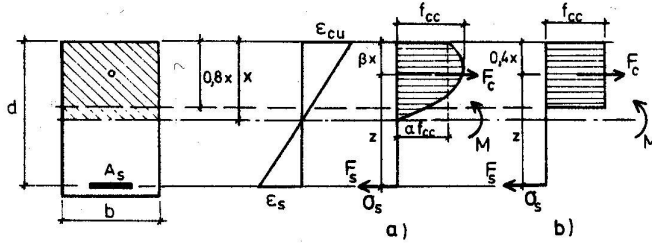

Figure 1: Stress distribution according to BHK 3.6:43, figure 3.6:12b, (a) real distribution of compressive stress, (b) simplified distribution

The relative moment  $m = M/f_{cc}bd^2$

Relative effective compression zone height  $\omega_c = 0,8x/d$

Mechanic reinforcement amount  $\omega_s = \sigma_s/f_{cc} \cdot \rho$

Reinforcement amount  $\rho = A_s/bd$

A lower limit for the lever R has been set to  $0.1 \times$  the effective depth.

If the current moment is bigger than the moment representing balanced design, compression reinforcement will be provided. If the spacing regulations for the reinforcement are exceeded before adequate moment capacity can be reached, a warning message will be given by the PC-program.

The reinforcement is practically arranged regarding reinforcement distances according to BBK94 3.9.6 and BHK 3.9.5.

## Shear capacity

The shear capacity  $V_c$  is calculated according to BBK94 3.7.3 and is assumed to be sufficiently high if:

$$V_{sd} \leq V_c + V_i$$

where:

$V_{sd}$  is the shear force caused by the design load

$V_c$  is the shear capacity of concrete (according to BBK 3.7.3.2-5)

$V_i$  is the influence of variable effective height (according to BBK 3.7.3.6)

$$V_c = b_w d f_v$$

where:

$b_w$  is the section width within the effective height in current cross-section

$d$  is the effective height

$f_v$  is the basic design shear strength, given by:

$$f_v = \xi(1+50)0,30f_{ct}$$

$$\xi = 1,4 \quad \text{for } d \leq 0,2 \text{ m}$$

$$\xi = 1,6-d \quad \text{for } 0,2\text{m} < d \leq 0,5 \text{ m}$$

$$\xi = 1,3-0,4d \quad \text{for } 0,5 \text{ m} < d \leq 1,0\text{m}$$

$$\xi = 0,9 \quad \text{for } 1,0 \text{ m} < d$$

$$\rho = A_{s0}/(b_w d)$$

maximum allowed  $\rho = 0,02$

where:

$A_{s0}$  is the minimum bending reinforcement area of the tensile zone.

## Punching

The slab capacity with respect to punching at columns is calculated according to BBK94 6.5.4-5 and BHK 6.5:34. Possible shear reinforcement is calculated. The slab capacity according to BBK is the sum of a contribution from both the tensile strength of concrete and a contribution from the shear reinforcement. The calculation according to BHK is more dependent on the reinforcement.

By small amounts of reinforcement, the capacity of the slab can be calculated by BBK, but for increased reinforcement, more beneficial values may be estimated with the method according to BHK.

The maximum capacity according to the method of BHK is for slabs without shear reinforcement limited to the basic shear strength according to BHK6.5:342.

Within the calculation according to BHK (figure 6.5:37) the slab diameter  $C$  is estimated as:

$$C = 0.5 \sqrt{\frac{F}{q}}$$

where  $F$  is current punching load and  $q$  is evenly distribution of load on the slab per surface unit. For various amount of reinforcement in the two perpendicular directions, the average value calculated according to BBK is used also for the method of calculation in BHK. A column is calculated as a corner column if the distance between slab edge and column edge both in either the X- or the Y-direction is smaller than the slab thickness. A column is calculated as an edge column if the distance between slab edge and column edge in X- or Y direction is smaller than the slab thickness. In all other cases the column is treated as an interior column.

### Critical perimeter (design size of the column)

For calculation of the risk of punching failure the following “critical perimeter” of the columns is used (critical perimeter is the effective size of the column).

*Interior column*

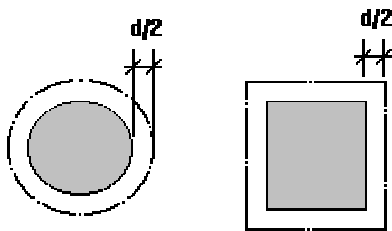

*Edge column*

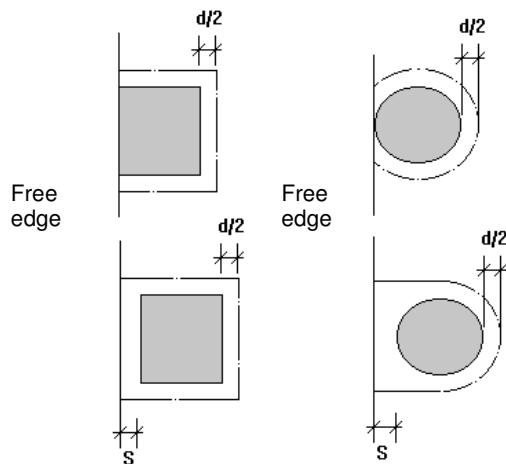

For the distance  $S$  shown above is maximum=the slab thickness

### Corner column

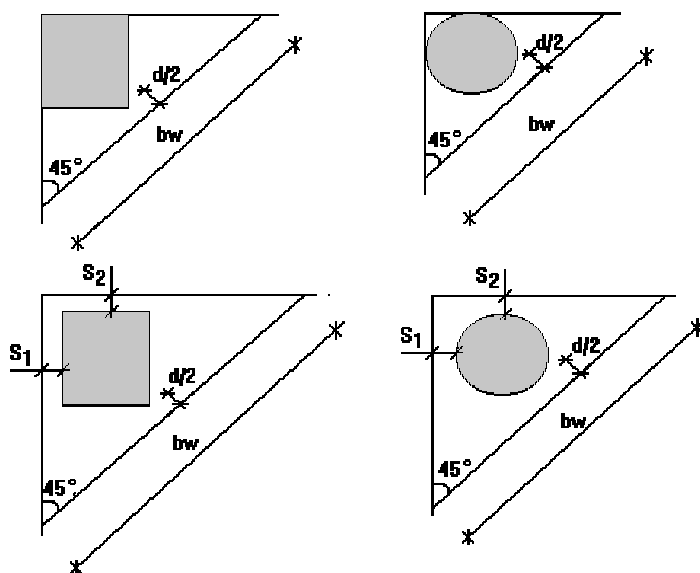

The maximum distances  $S_1$  och  $S_2$  above, are equal to the slab thickness.

If the section of the column is large or oval the “critical perimeter” will be divided into one part  $U_1$ , which is calculated regarding punching and one part  $U_0$ , which is calculated regarding shear strength. Total capacity consists of the summary of the different two parts.

### Shear reinforcement

If the shear capacity is insufficient, shear reinforcement will be calculated according to BHK 6.5:345 for internal and edge columns. The shear reinforcement is assumed to consist of bent reinforcement where the bending angle is chosen to 60 degrees.

## 2.2 Serviceability limit state

The PC-program FEM-Design Plate (1990) performs crack- and deflection control for all load combinations according to BHK 4:5 and 4:6. Two limiting conditions are assumed to exist for the calculations: Stadium I (uncracked condition) and Stadium II (fully cracked condition)

The program considers the decrease in slab stiffness due to cracking. This means that the program performs an iterative calculation where the slab in the beginning is assumed to be uncracked when the section forces are calculated. As the next step, the moment is compared to the crack moment of the slab in order to differ the parts of the slab, which belongs to stadium I versus Stadium II.

In the next step a new calculation based on the new stiffness distribution is performed, and so on. When the deflection values resulting from two calculations do not differ more than a specific percentage of the first one ore the maximum number of allowed calculations has been reached the calculation is stopped.

The criteria when the concrete should be considered as cracked is at a state of pure bending:

$$\sigma_m \leq k (f_{ct} / \zeta)$$

where  $\sigma_m$  is stresses resulting from moments,  $f_{ct}$  is the design concrete tensile strength,  $\zeta$  is a crack safety factor and  $k$  is a coefficient according to BBK figure 4:5.1 or as follows:

$$k = 0.6 + \frac{0.4}{\sqrt[4]{h}}$$

Crack width is, according to BBK 94 4.5.5, calculated as:

$$w_k = 1.7 v S_{rm} \sigma_s / E_s$$

where:

$\sigma_s$  is the stresses of reinforcement in the crack,

$S_{rm}$  is the average final crack spacing,

$v$  is a coefficient regarding the influence of concrete located between cracks,

$$v = 1 - (\beta / 2,5 \chi_1) (\sigma_{sr} / \sigma_s)^2; v \geq 0.4$$

where:

$\sigma_{sr}$  is the stress of reinforcement in the crack when crack load,

$\beta$  is a coefficient considering the influence of long time load and repeated load

$\beta = 1.0$  for the first load,

$\beta = 0.5$  for long time load and repeated load,

$\chi_1$  is a coefficient considering reinforcement bond,

$\chi_1 = 0.8$  for anchored bars,

$\chi_1 = 1.2$  for ribbed bars,

$\chi_1 = 1.6$  plain bars.

The average final crack spacing,  $S_{rm}$ :

$$S_{rm} = 50 + \chi_1 \chi_2 \phi / \rho_r$$

where:

$$\rho_r = (A_s / A_{ef})$$

$A_s$  is reinforcement area,

$A_{ef}$  is the effective area of concrete, defined according to the figure below,

$\chi_2$  is a coefficient considering the strain within  $A_{ef}$ , see figure:

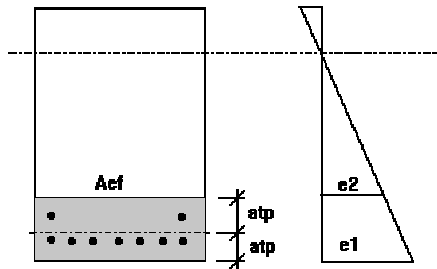

## Deformations

### Stadium I: Uncracked condition

Load dependent curvature is calculated as:

$$1 / r_f = M / E_{cc} I_1$$

where:

$M$  is current moment,

$I_1$  is moment of inertia in Stadium I,

$E_{cc}$  is the modulus of elasticity for concrete considering creep.

The modulus of elasticity is calculated as:

$$E_{cc} = E_c / (1 + \varphi) \text{ where } \varphi \text{ is the creep coefficient.}$$

Curvature with respect to shrinkage is not considered in the calculations.



### Stadium II: Fully cracked condition

Load dependent curvature is calculated as:

$$1 / r_f = M / E_{cc} I_2$$

where:

$E_{cc}$  is the modulus of elasticity as shown above,

$I_2$  is the moment of inertia in stadium II,

$M$  is current moment.

Curvature with respect to shrinkage is not considered in the calculations.

Sections which are close to cracking are supposed to behave in a manner intermediate between the uncracked and fully cracked conditions and an adequate prediction of behaviour is given by:

$$\alpha = v \alpha_{II} + (1 - v) \alpha_I$$

where:

$\alpha$  is the curvature calculated from the curvature of the uncracked  $\alpha_I$  and fully cracked  $\alpha_{II}$  conditions,

$v$  is a coefficient, which considers the influence of tensioned concrete between cracks according to BBK94 4.5.5:

$$v = 1 - (\beta / 2.5 \chi_1) (\sigma_{sr} / \sigma_s)$$

where:

$v \geq 0.4$  for fully cracked sections and 0 for uncracked sections,

$\chi_1$  and  $\beta$  are coefficients taking account of bond properties and duration of loading respectively, see above.

$\sigma_s$  is the (steel) stress at the crack according to BBK94 4.3,

$\sigma_{sr}$  corresponds to the value of  $\sigma_s$  calculated on the basis of a cracked section under the loading which will just cause cracking at the section being considered.

## 3. Loads (according to the Swedish Code BBK94)

| Load type                 | Value                 | Partial coeff. $\gamma_f$ (ultim.) | Partial coeff. $\gamma_f$ (serv.) | Load red. coeff. $\psi$ |
|---------------------------|-----------------------|------------------------------------|-----------------------------------|-------------------------|
| $G_k$ Dead load:          | 2,4 kN/m <sup>2</sup> | 1,0                                | 1,0                               |                         |
| $Q_k$ Variable bound load | 0,5 kN/m <sup>2</sup> | 1,3                                | 1,0                               | 1,0                     |
| $Q_k$ Variable free load  | 1,5 kN/m <sup>2</sup> | 1,3                                | 1,0                               | 0,33                    |

### Ultimate limit state:

Design situations with only one variable action  $Q_{k,1}$

$$\text{BBK94 } S_d = \Sigma \gamma_G G_k + \gamma_Q Q_{k,1}$$

Design situations with two or more variable actions  $Q_{k,i}$

$$\text{BBK94 } S_d = \Sigma \gamma_G G_k + \gamma_Q Q_{k,1} + \Sigma \psi Q_{k,i}$$

### Default values:

**Permanent load** Min. safety factor 0.85 and max safety factor 1.0.

**Variable load** Safety factor 1.3 and same time factor 0.5.

All variable loads will in turn be considered as **Main load** and thereby be considered as  $Q_{k,1}$  and be multiplied by  $\gamma_Q$ .

**Note:** The above will cover combination 1 and 2, see BKR99 2:321. To also cover combinations 3 and 4, the user will have to change these factors.

### Serviceability limit state:

Only one variable action  $Q_{k,1}$

$$S_d = \Sigma G_k + Q_{k,1}$$

Two or more variable actions  $Q_{k,i}$

$$S_d = \Sigma G_k + Q_{k,1} + \Sigma \psi Q_{k,i}$$

$$S_d = \Sigma G_k + \Sigma \psi Q_{k,i}$$

**Example:**

One permanent load  $G_k$  and three variable loads  $Q_{k,1}$ ,  $Q_{k,2}$  and  $Q_{k,3}$ . The user has chosen 1.0 as both max and min. safety factor for the permanent load  $G_k$  but has accepted the other default values described above. The required combinations put up by the programme will in this case be the following 13:

**1.**  $1.0 G_k$  **2.**  $1.0 G_k + 1.3 Q_{k,1}$  **3.**  $1.0 G_k + 1.3 Q_{k,2}$  **4.**  $1.0 G_k + 1.3 Q_{k,3}$  **5.**  $1.0 G_k + 1.3 Q_{k,1} + 0.5 Q_{k,2}$  **6.**  $1.0 G_k + 1.3 Q_{k,1} + 0.5 Q_{k,3}$  **7.**  $1.0 G_k + 1.3 Q_{k,2} + 0.5 Q_{k,1}$  **8.**  $1.0 G_k + 1.3 Q_{k,2} + 0.5 Q_{k,3}$  **9.**  $1.0 G_k + 1.3 Q_{k,3} + 0.5 Q_{k,1}$  **10.**  $1.0 G_k + 1.3 Q_{k,3} + 0.5 Q_{k,2}$  **11.**  $1.0 G_k + 1.3 Q_{k,1} + 0.5 Q_{k,2} + 0.5 Q_{k,3}$  **12.**  $1.0 G_k + 1.3 Q_{k,2} + 0.5 Q_{k,1} + 0.5 Q_{k,3}$  **13.**  $1.0 G_k + 1.3 Q_{k,3} + 0.5 Q_{k,1} + 0.5 Q_{k,2}$

**References**

- BHK Handbook of Concrete – Design (Swedish Building Centre 1990)  
Swedish Building Centre (1990), *Handbook of Concrete – Design*, Solna: AB Svensk Byggtjänst (in Swedish).
- BBK Swedish Concrete Building Code BBK94 (Boverket, 1994)  
Boverket (1994), *BBK 94 Boverkets Handbok om Betongkonstruktioner*, Karlskrona: The Swedish Board of Housing, Building and Planning (in Swedish).
- FEM- Design Plate 3.50 Manual, (2000), PC-based computer program, Malmö: Skanska IT Solutions.

# **Appendix B**

## **Structural design study – results**

### **1. Diagrams**

#### **1.1. General**

#### **1.2. Ultimate limit state – slab type 1 and 4**

#### **1.3. Serviceability limit state – slab type 1**

#### **1.4. Diagrams for all slab types**

### **2. Tables**

# 1. Diagrams

## 1.1 General

This appendix presents result diagrams for all slab types (span as function of amount of evenly distributed reinforcement based on the maximum moment, with regard to slab thickness, compressive strength and tensile strength), shown in paragraph 1.2 –1.4.

## 1.2 Ultimate limit state

In diagrams 1 and 2 below the bold curves show the possible spans with regard to various amount of reinforcement in the ultimate limit state. Each curve represents a specific strength class (K-value) and slab thickness.

Diagram 3 shows the effect of punching. Comparison with Diagram 2 shows that the possible spans are heavily reduced when ordinary tensile strength is used.

The grey curves show the possible span with regard to serviceability limit state.

Diagram 1: Slab type 1 (see Figure 3.2)  
Relation between the amount of reinforcement (designed for maximum field moment) and the possible span

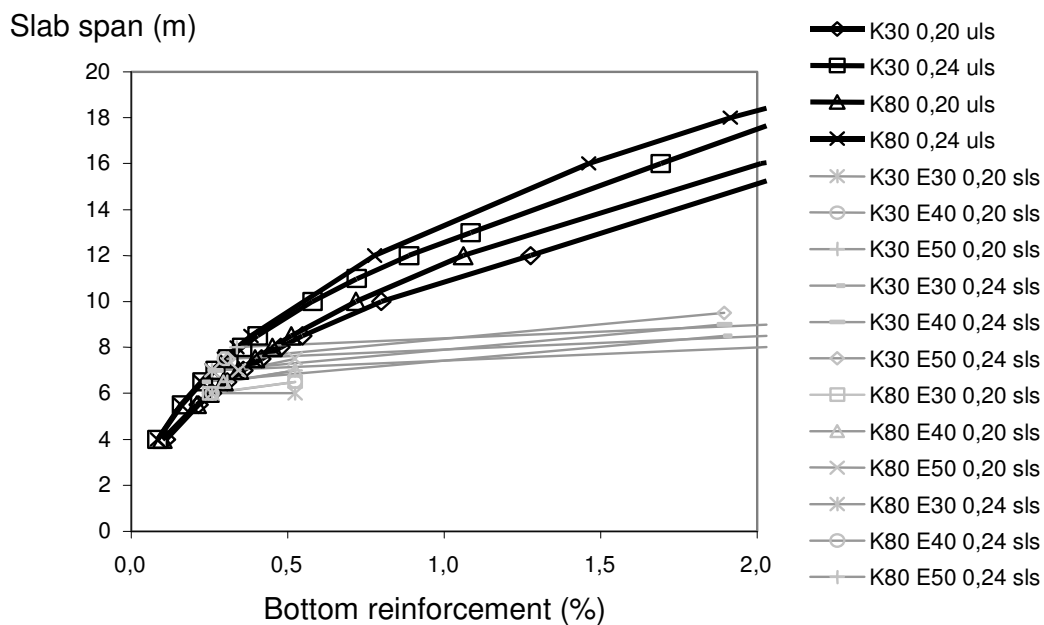

Diagram 2: Slab type 4 (see Figure 3.5)  
 Relation between the amount of reinforcement (designed for maximum field moment) and the possible span. No consideration to punching.

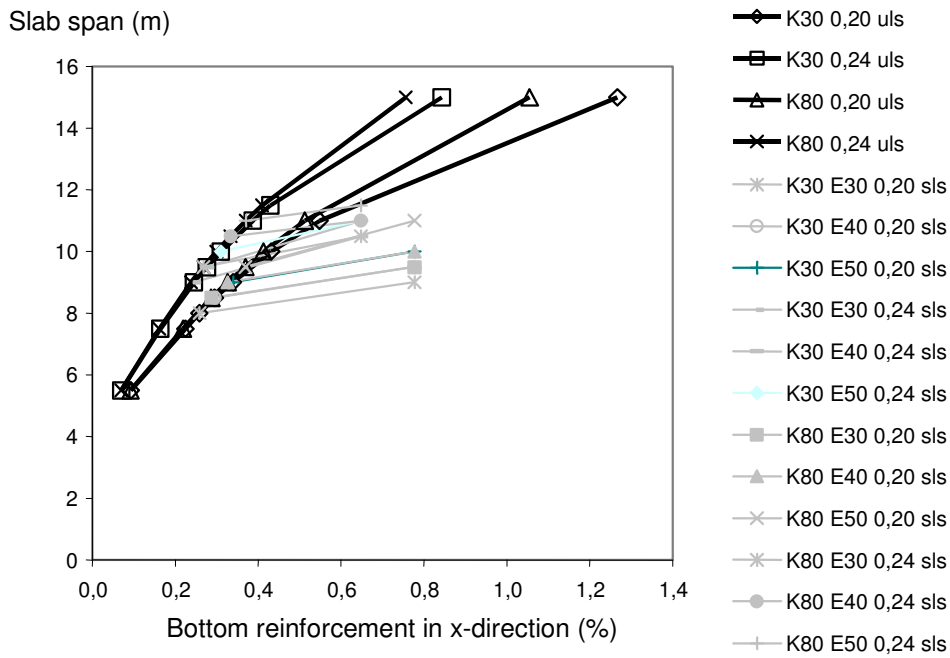
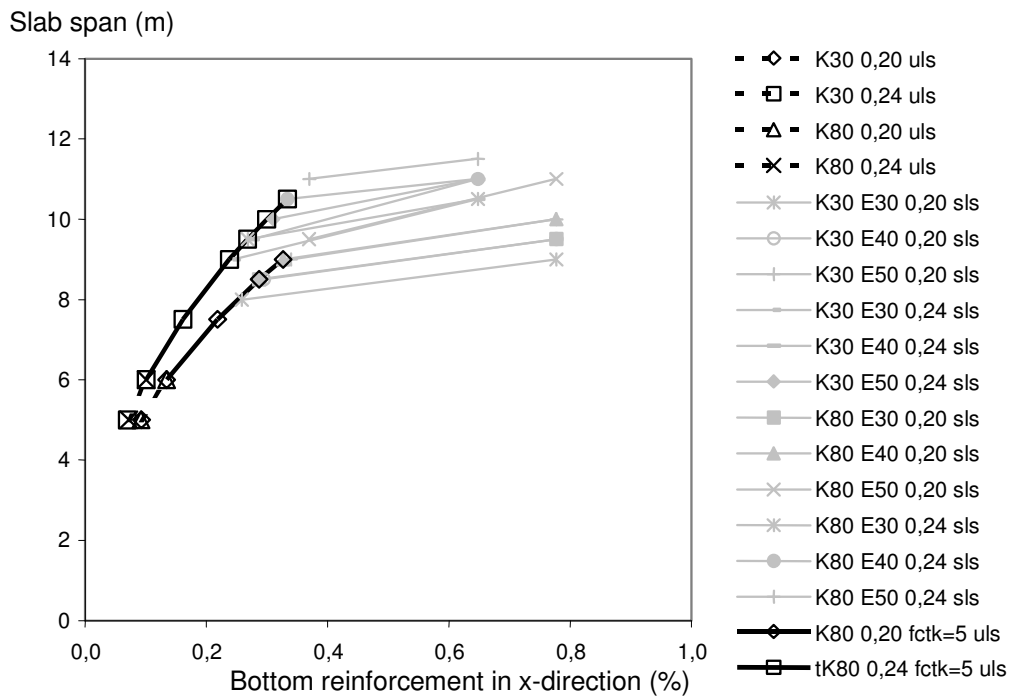

Diagram 3: Slab type 4  
 The same as Diagram 2 but consideration taken to punching



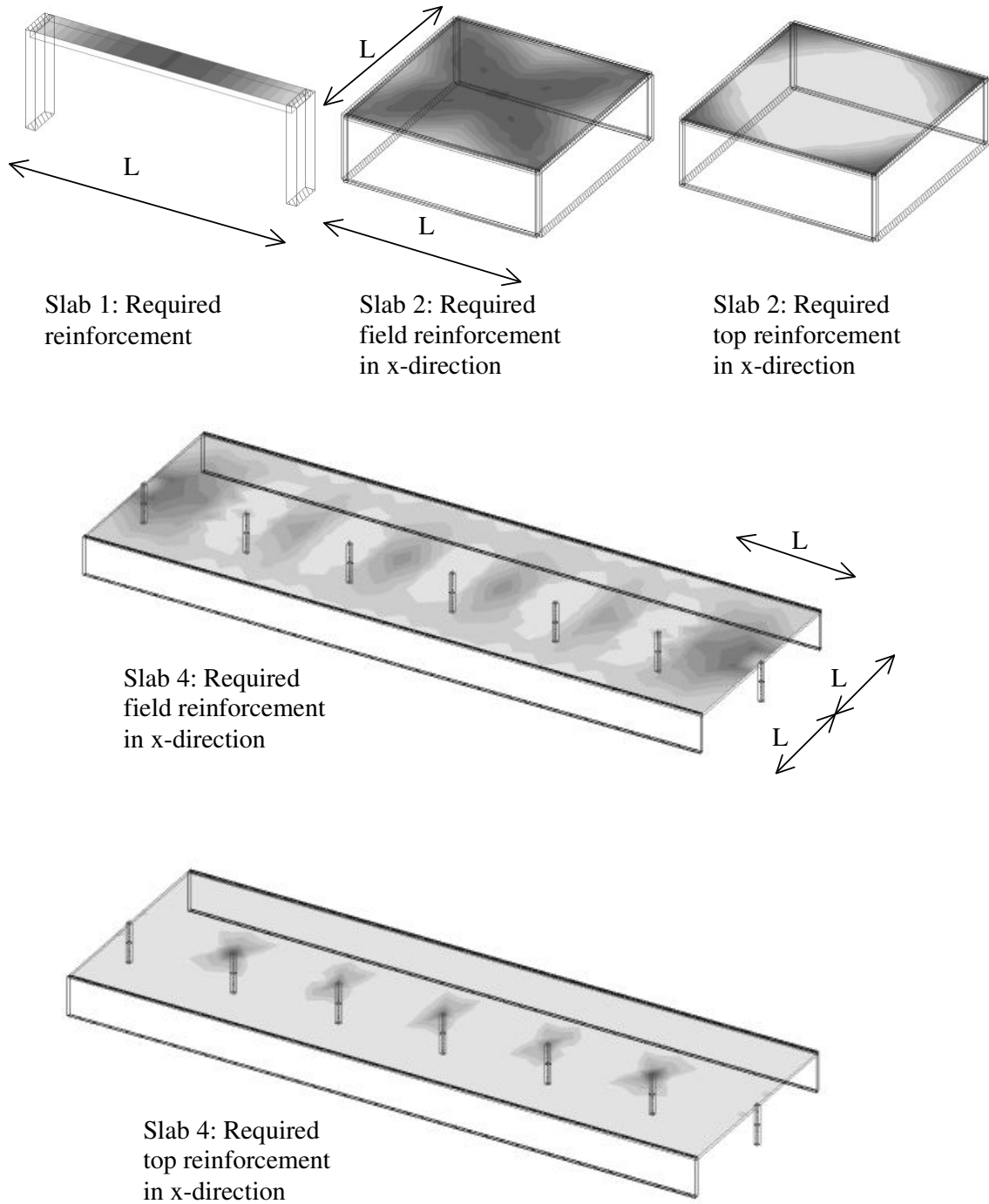

Figure 3.1: The required reinforcement for slabs 1, 2 and 4 are exemplified. Most dark area indicates required reinforcement considering maximum moment. Lightest area indicates no required reinforcement. Also the span ( $L$ ) is shown.

### 1.3 Serviceability limit state – slab type 1

#### Result examples

In diagram 4 below (the same as Diagram 1) the bold curves displays possible spans with regard to various evenly distributed amount of reinforcement in the *serviceability limit state*. Each curve represents a specific strength class (K-value), E-modulus and slab thickness. The displacement is limited to span divided with 400. The grey curves show the possible span with regard to the ultimate limit state.

Diagram 4: Slab type 1 (Figure 3.2)

Relation between the amount of reinforcement (designed for maximum field moment) and slab span for a maximum acceptable deflection of  $L/400$  where  $L$  is the span.

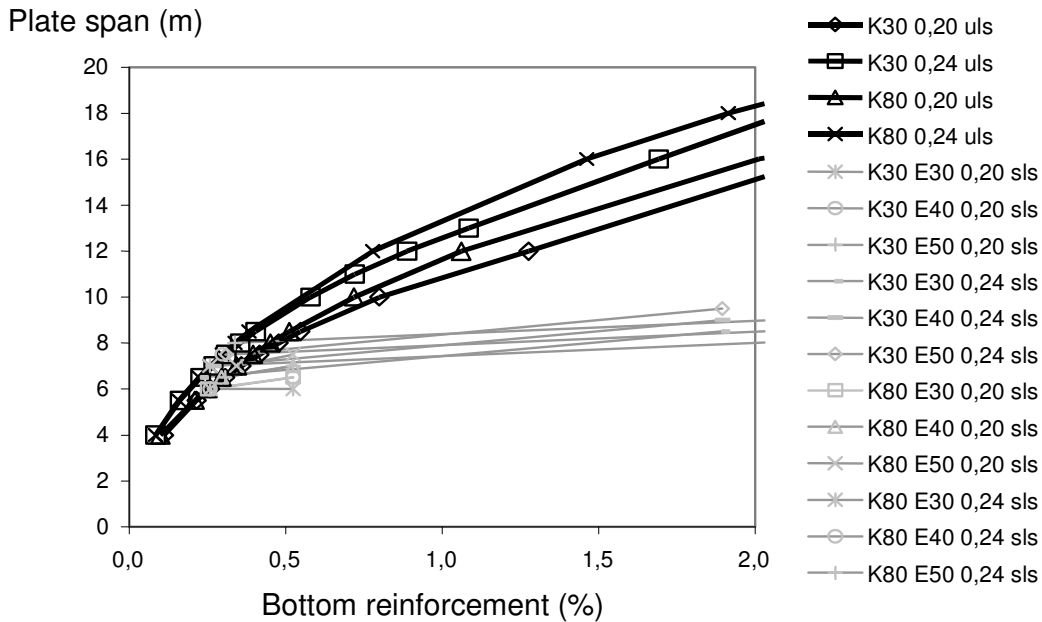

### 1.3 Diagrams for all slab types

Below, the result of the design study is presented as diagrams. There are diagrams for each type of slab. Each diagram displays possible span as a function of maximum required top respectively bottom reinforcement.

The reinforcement is designed for maximum moment in field and over support. E-modulus, and slab thickness is varied. The design tensile strength is 1,6 MPa for K30 and 2,5 MPa for K80. For slab 4-6 the effect of increasing to 5 MPa is calculated. Curves limited by either the ultimate limit state or the serviceability limit state, are displayed for each diagram. For the serviceability limit state the maximum deflection is  $L/400$ . In the ultimate limit state, the reinforcement amount and the plate thickness are the significant parameters. In the serviceability limit state, especially the E-modulus, the tensile strength and the plate thickness are the significant parameters.

Slab type 1 (Figure 3.2)

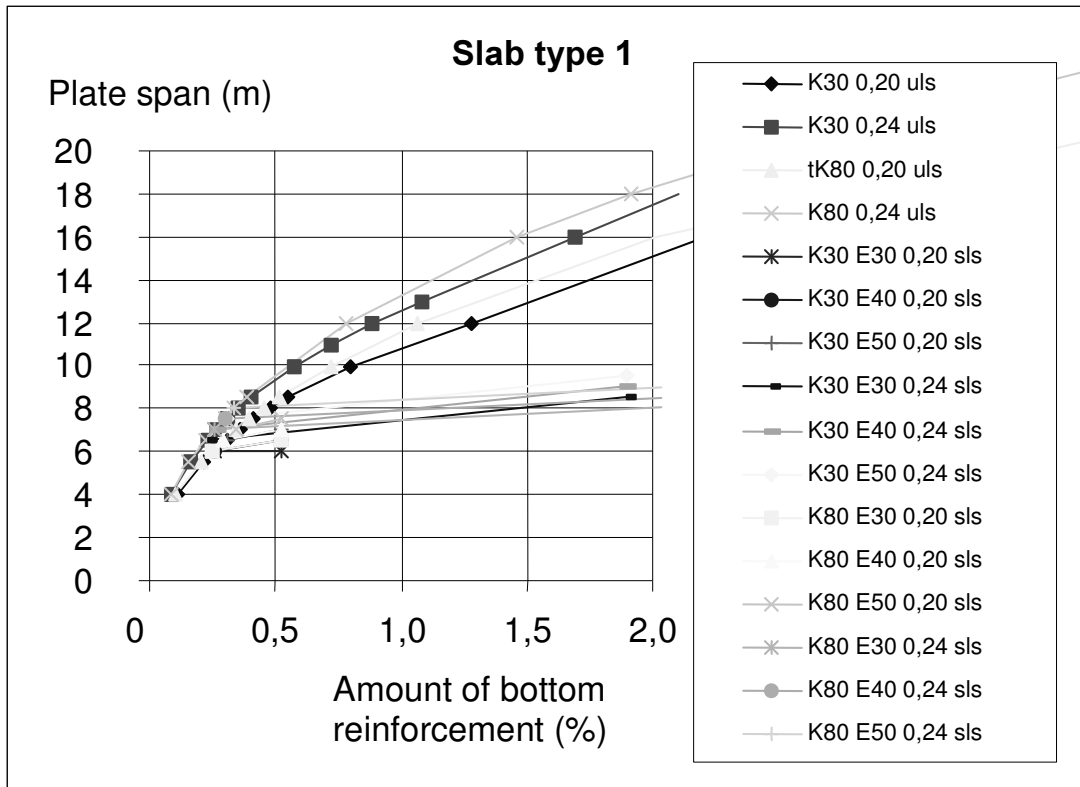



## Slab type 2 (Figure 3.3)

### (a) Reinforcement in x-direction

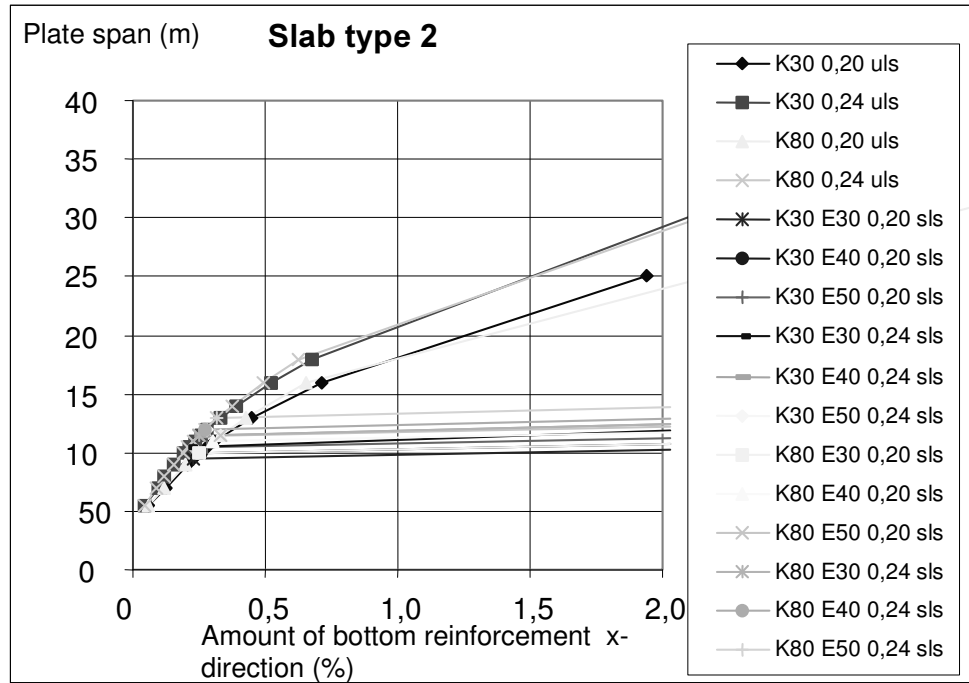

### (b) Reinforcement in y-direction

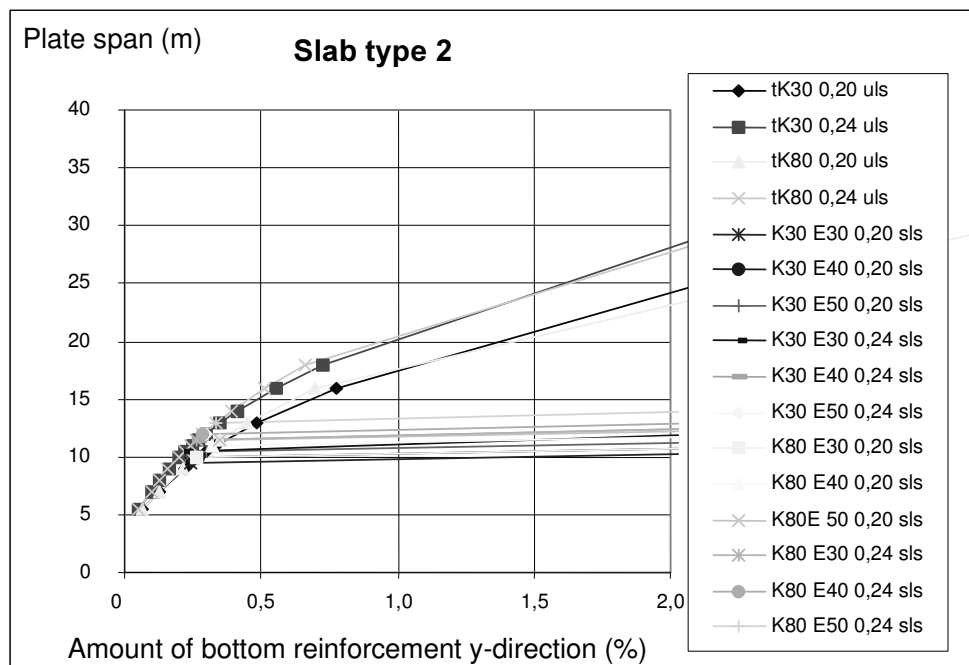

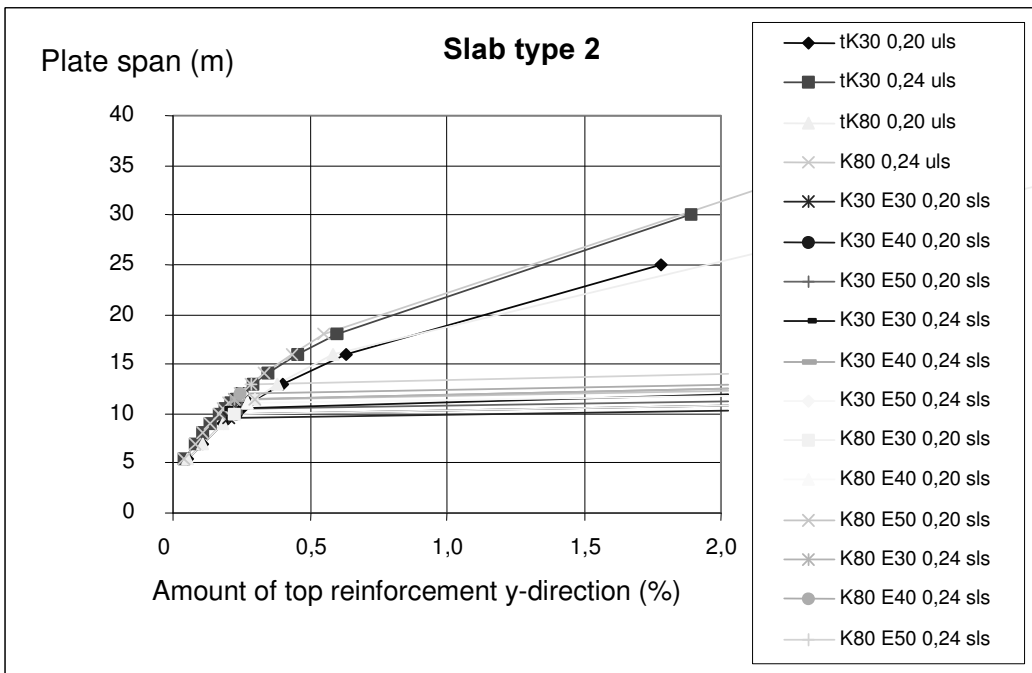
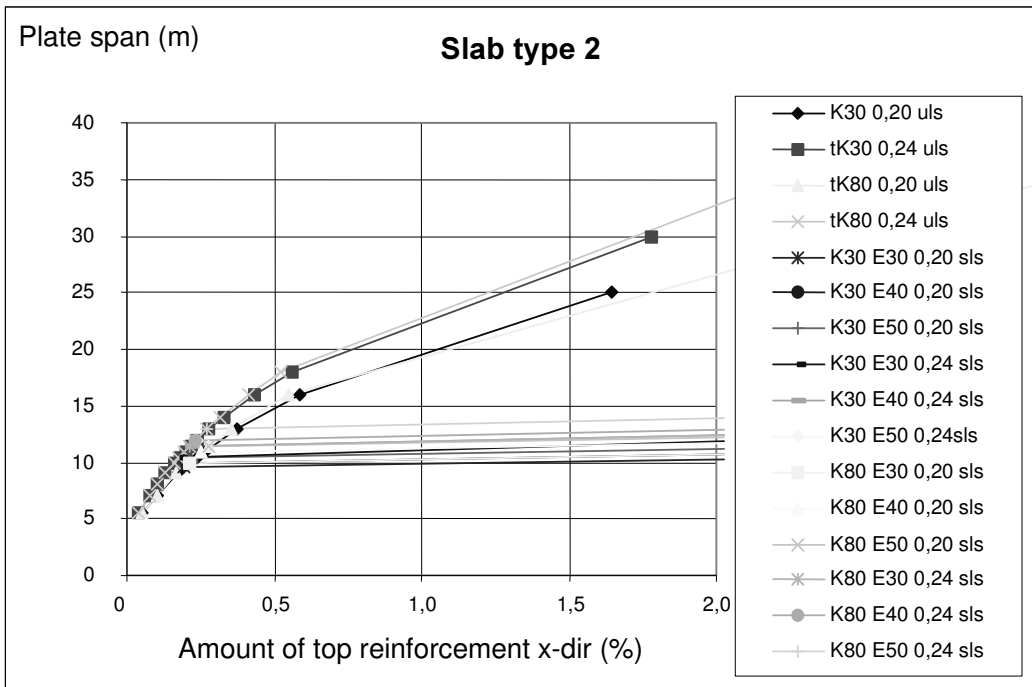

### Slab type 3 (Figure 3.4): Field reinforcement

#### (a) Reinforcement in x-direction

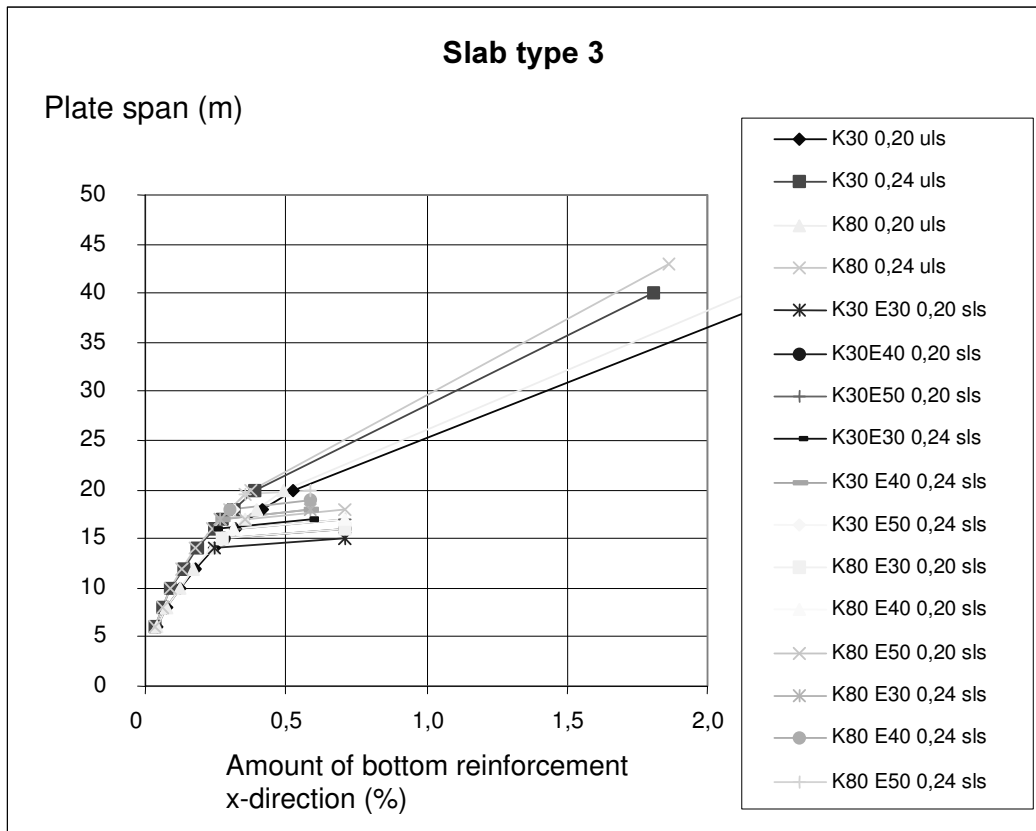

#### (b) Reinforcement in y-direction

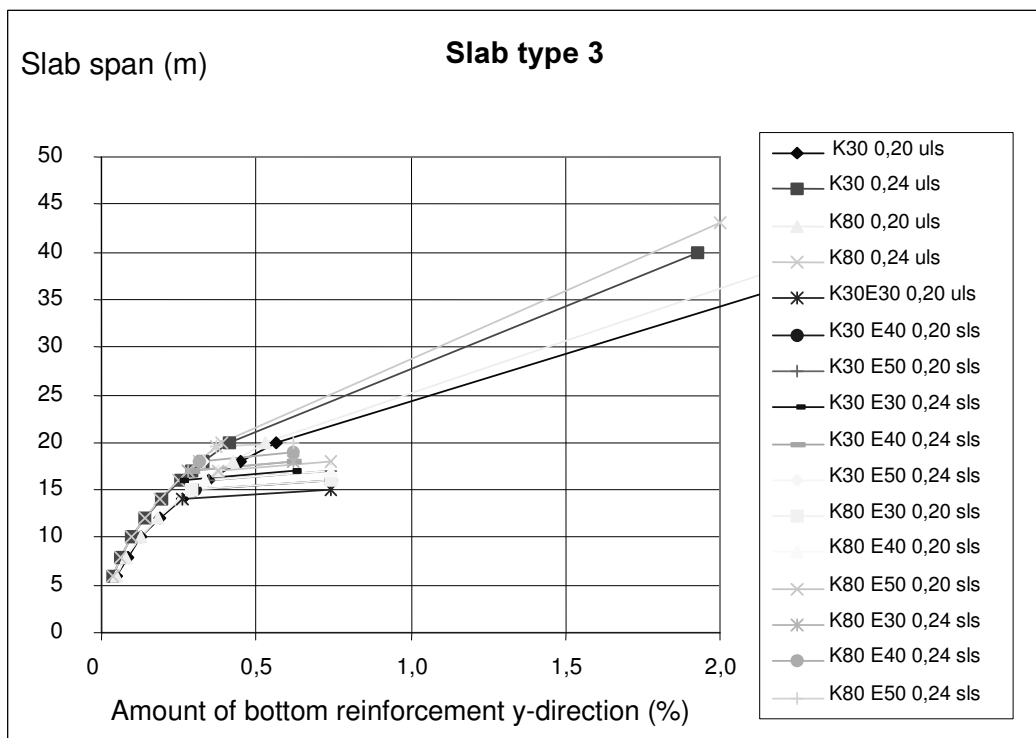

### Slab type 3 Top reinforcement

#### (a) Reinforcement in x-direction

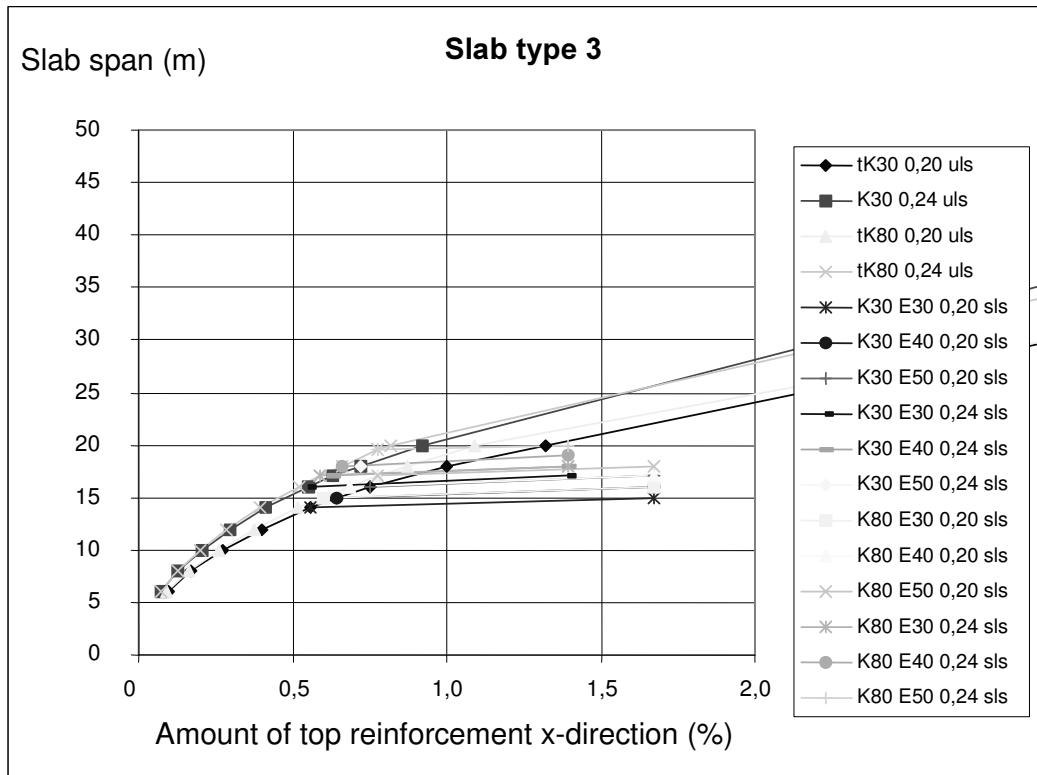

#### (b) Reinforcement in y-direction

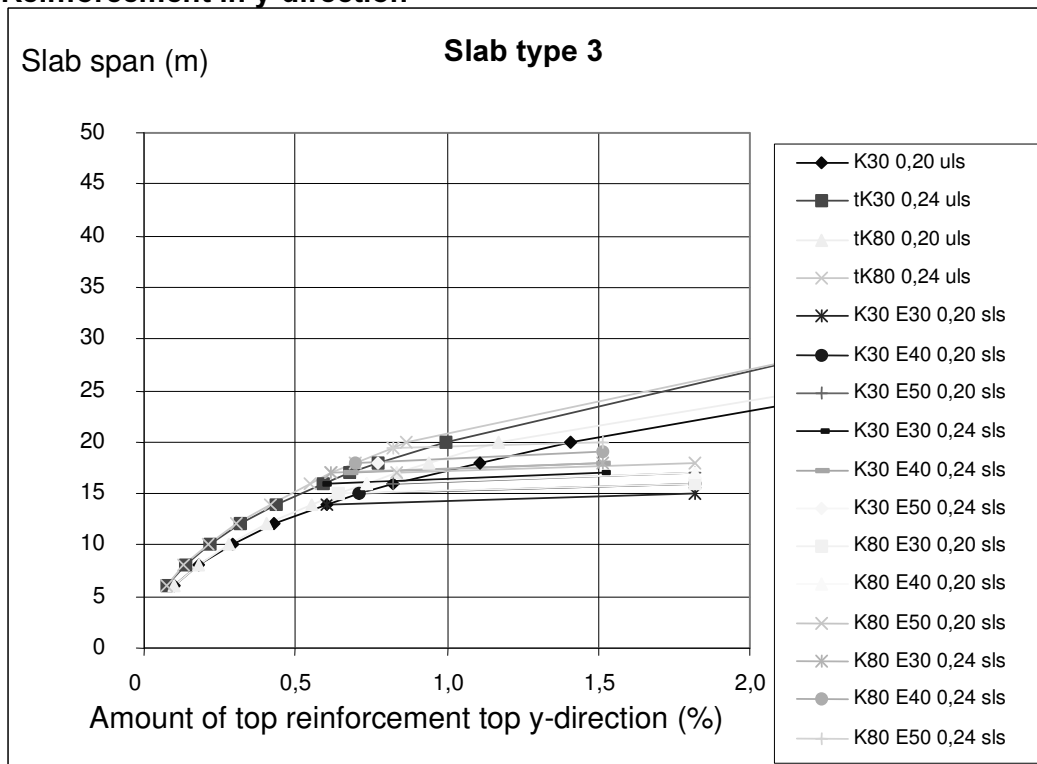

### Slab type 4 (Figure 3.5): Field reinforcement

The effect of increasing the tensile strength  $F_{ctk}$  from 2,5 MPa to 5,0 MPa for K80 is shown.

#### (a) Reinforcement in x-direction

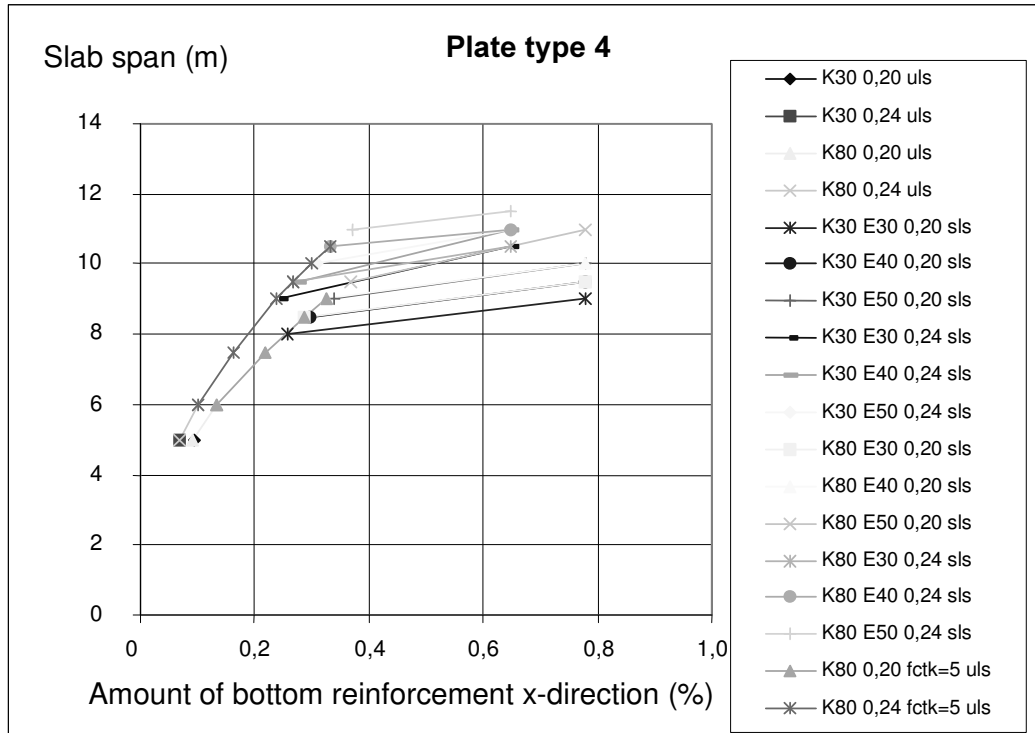

#### (b) Reinforcement in y-direction

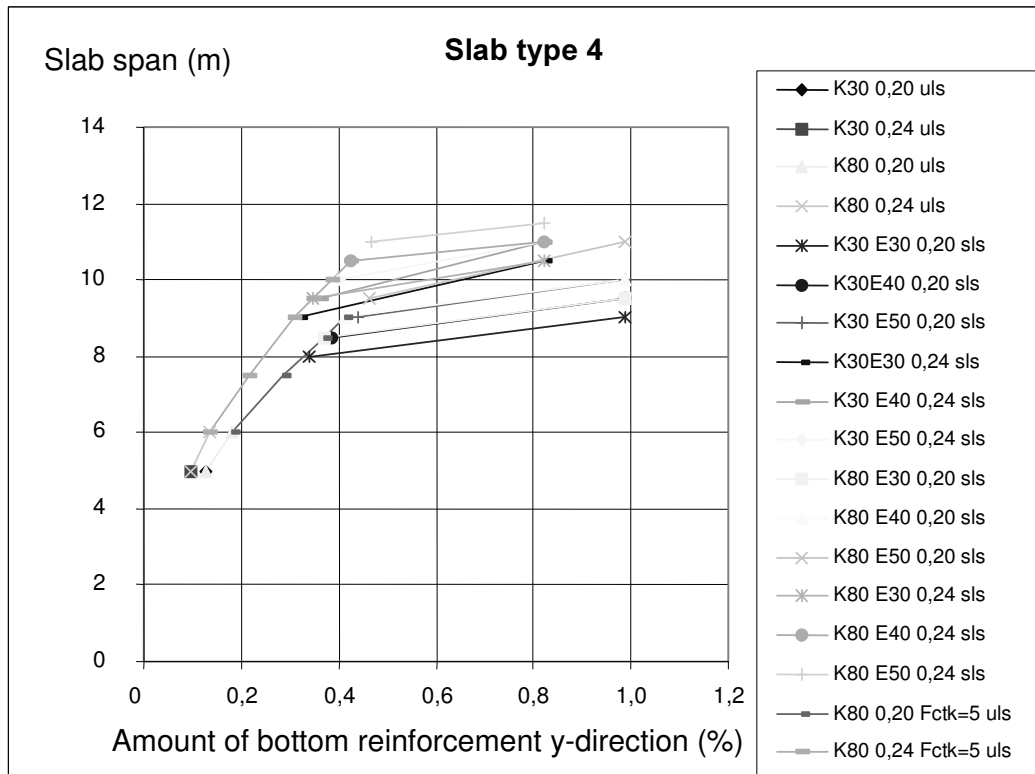

## Slab type 4 Top reinforcement

### (a) Reinforcement in x-direction

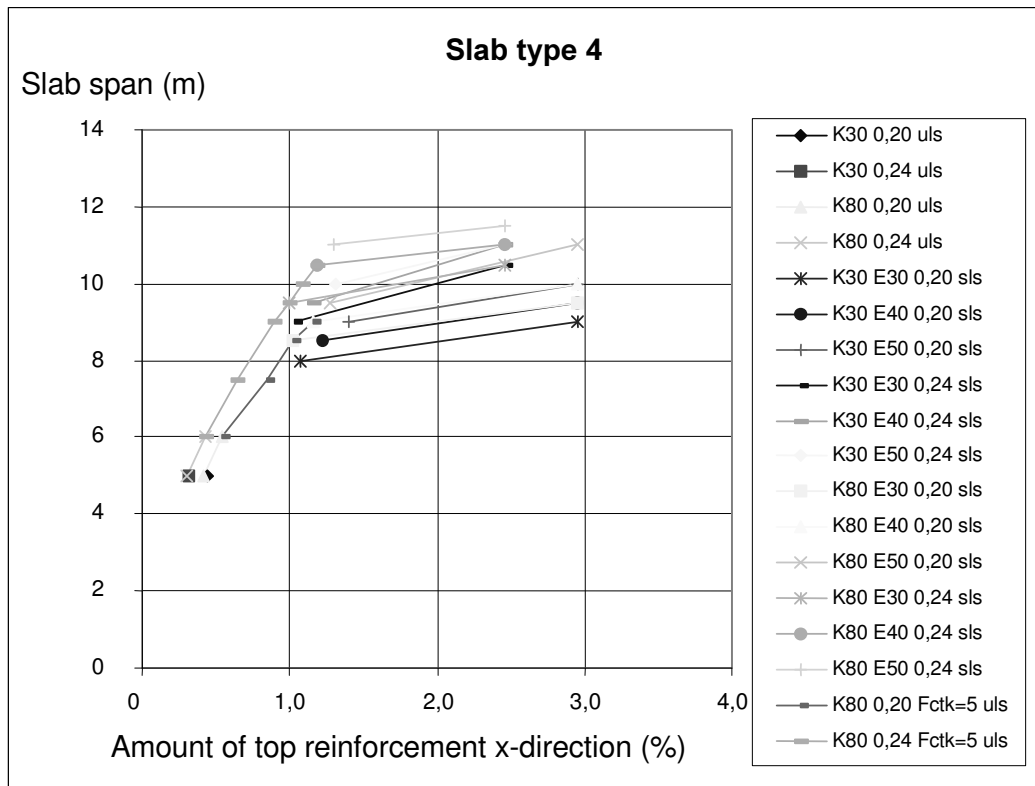

### (b) Reinforcement in y-direction

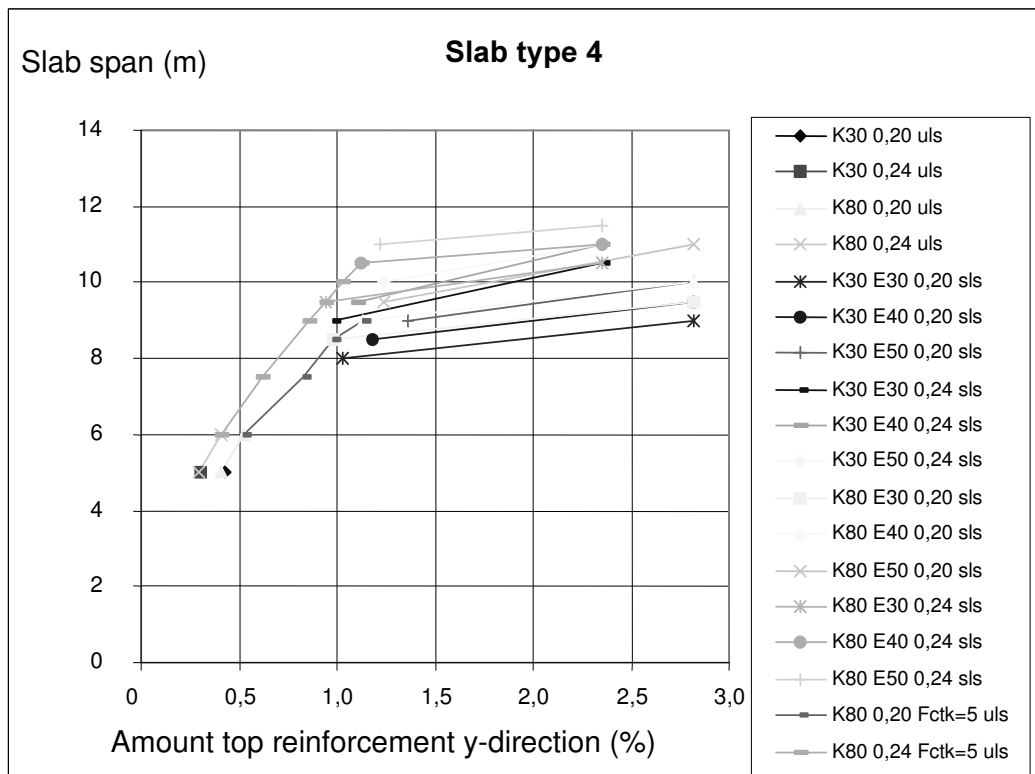

## Slab type 5 (Figure 3.6): Field reinforcement

### (a) Reinforcement in x-direction

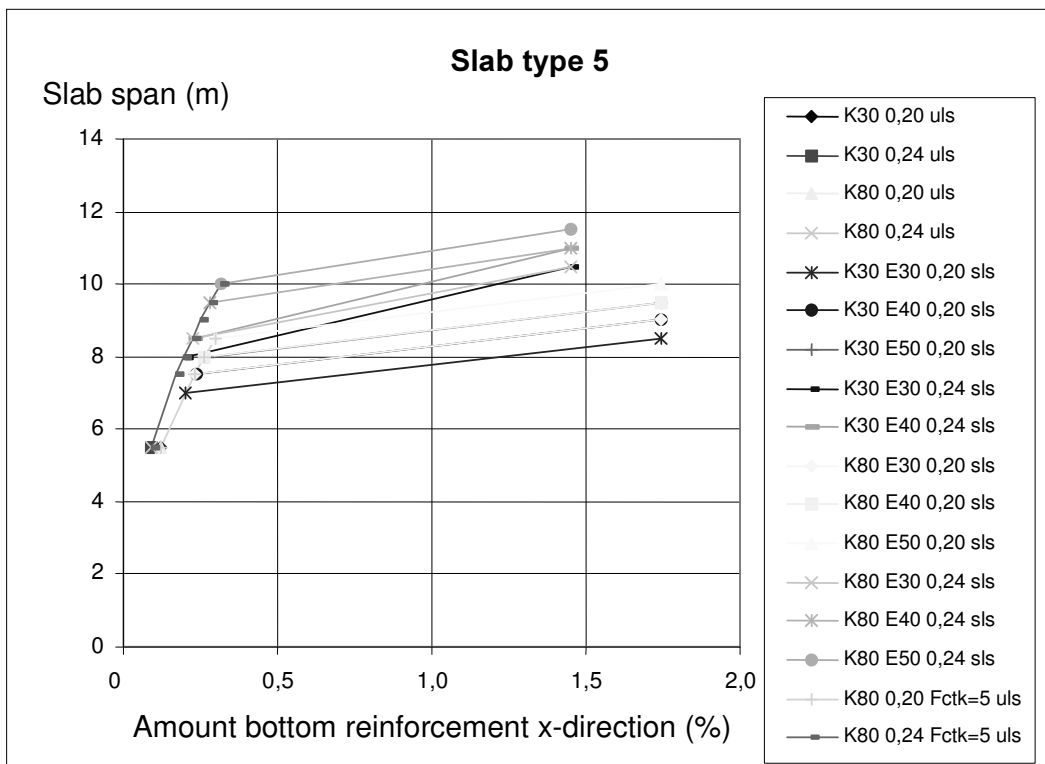

### (b) Reinforcement in y-direction

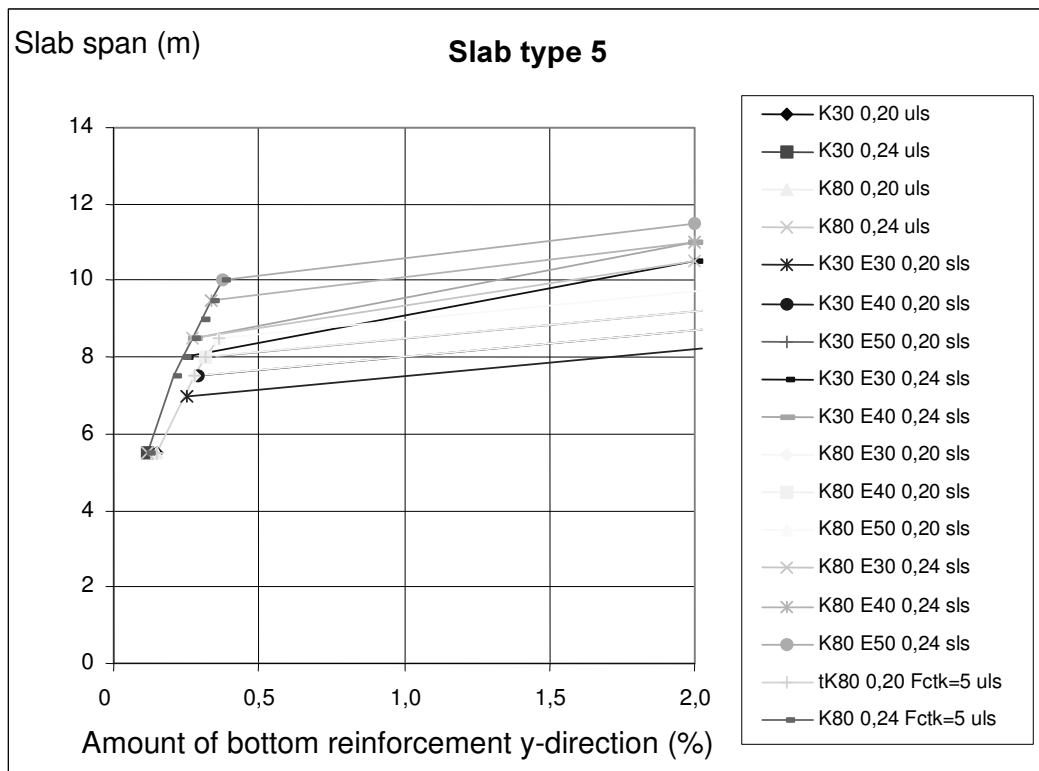

**Slab type 5: Field reinforcement**  
**(a) Reinforcement in x-direction**

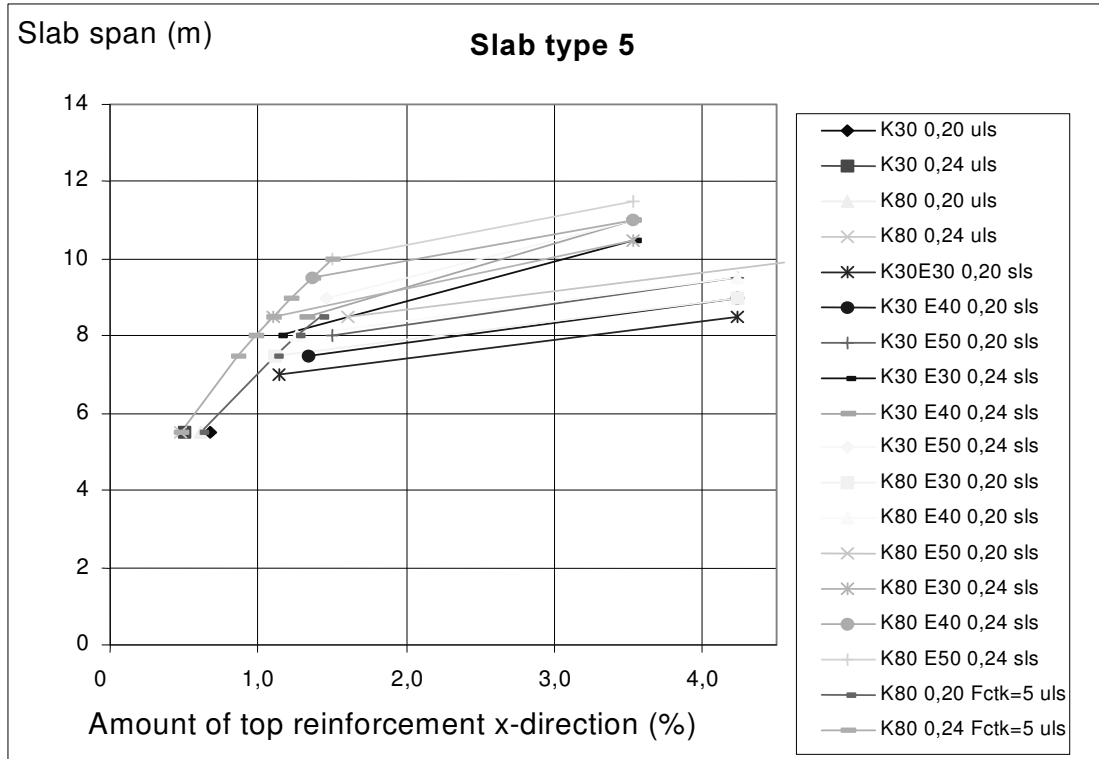

**(b) Reinforcement in y-direction**

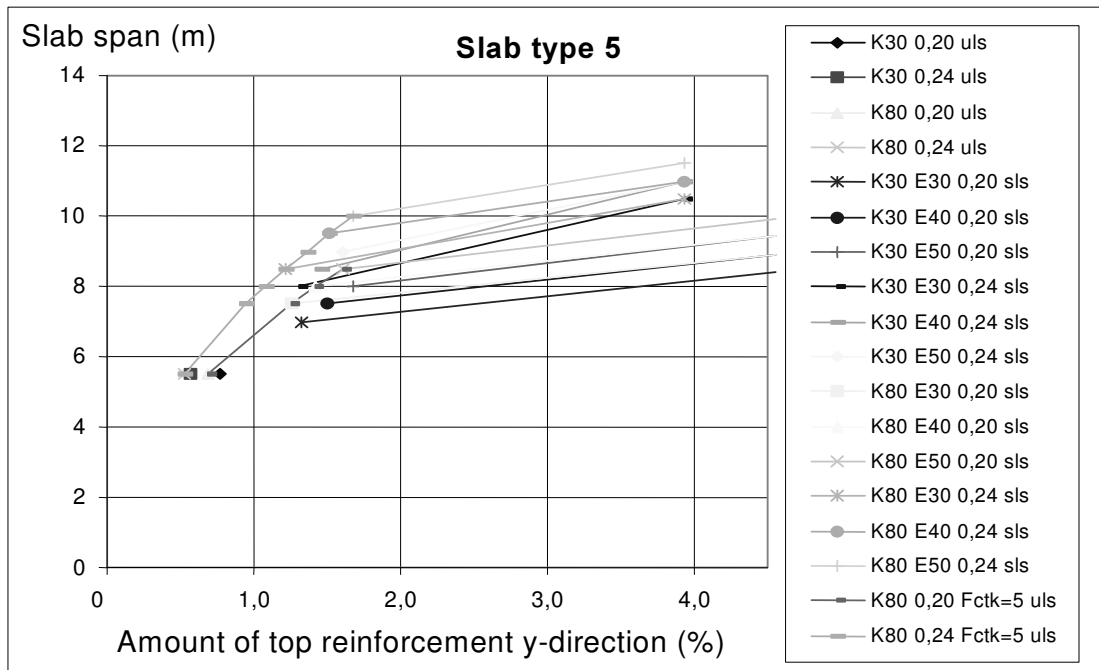



## Slab type 6 (Figure 3.7): Field reinforcement

### (a) Reinforcement in x-direction

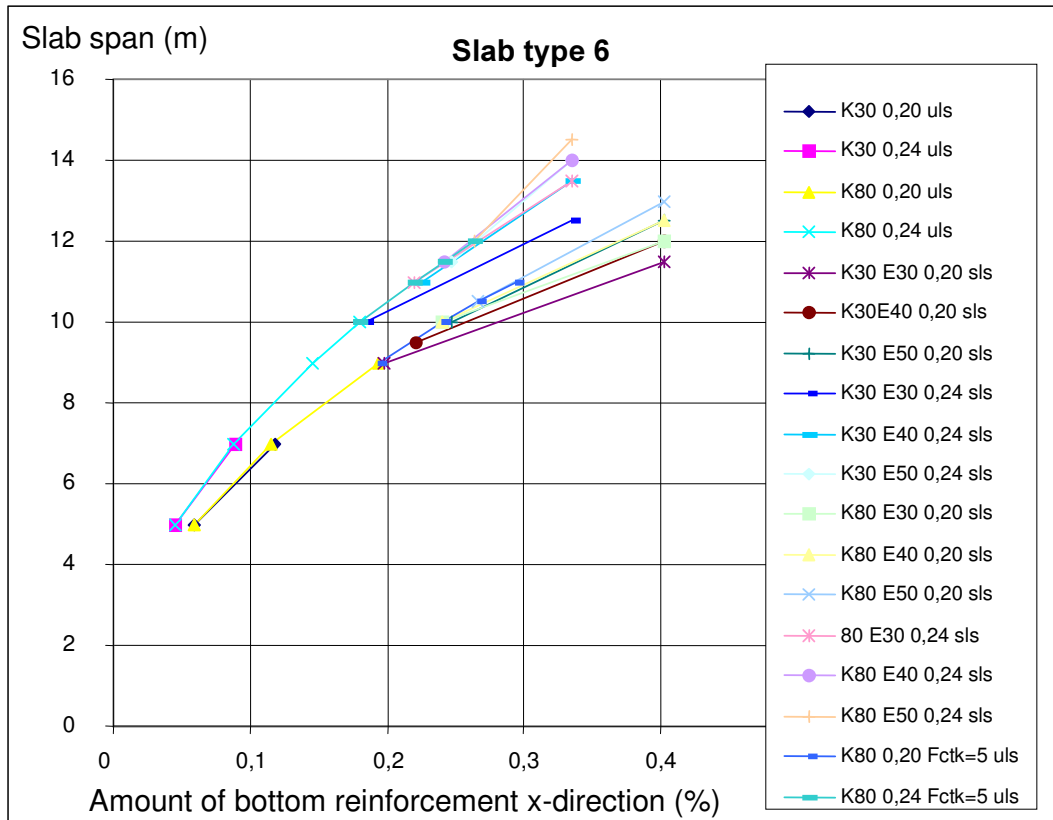

### (b) Reinforcement in y-direction

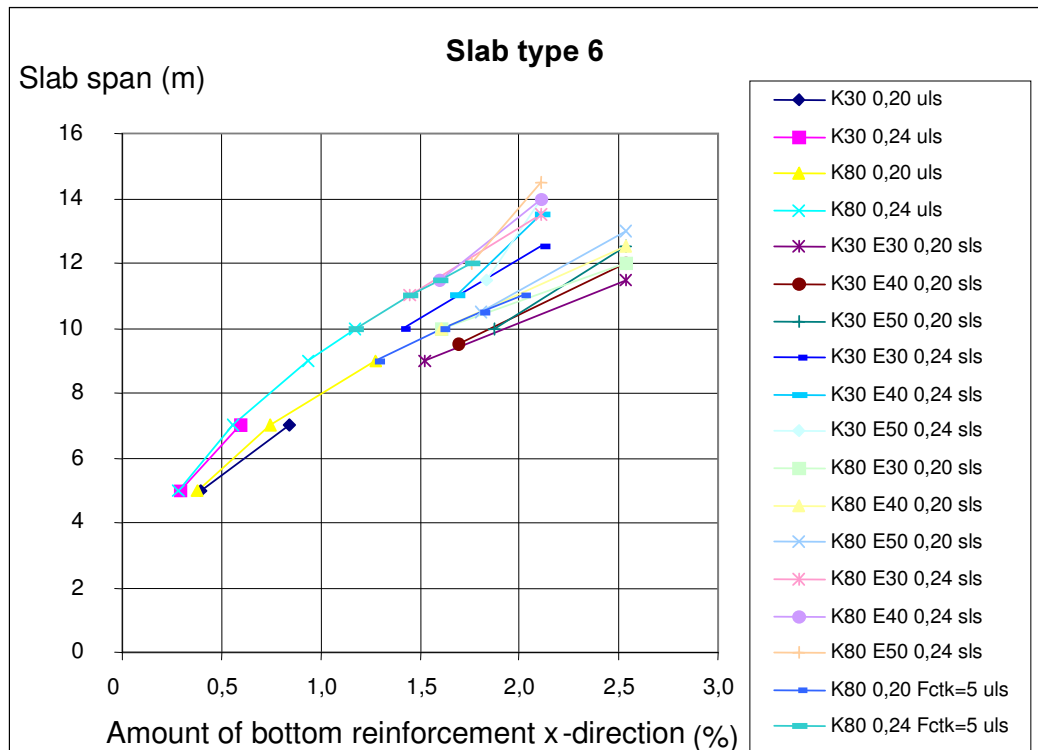

## Slab type 6: Top reinforcement

### (a) Reinforcement in x-direction

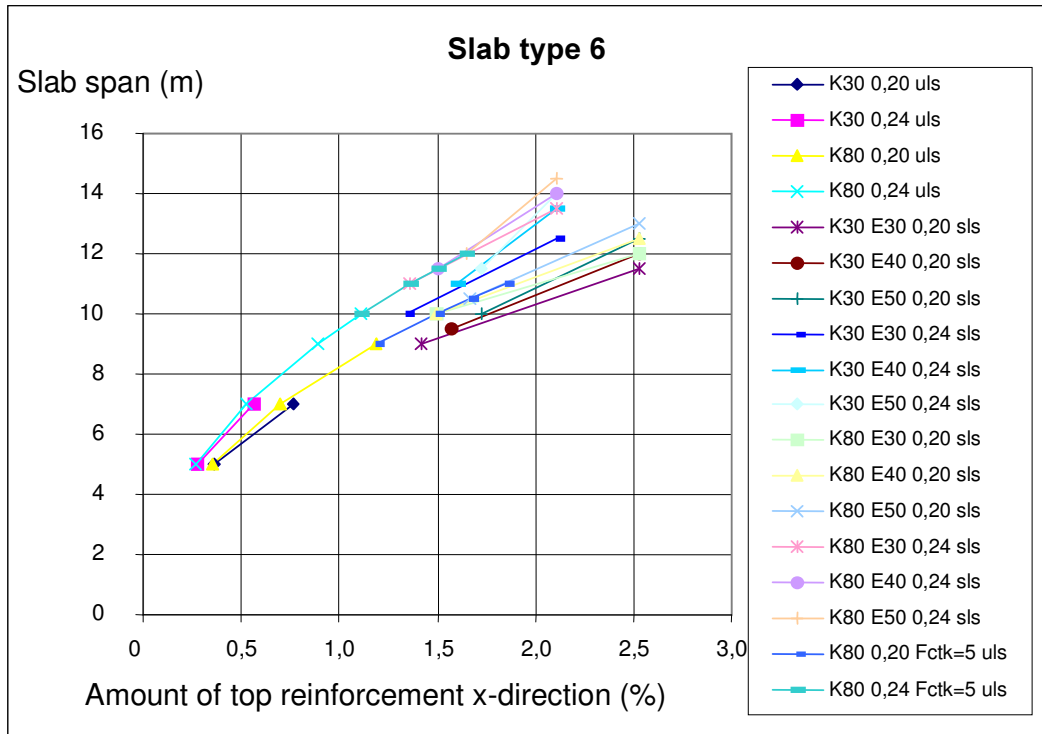

### (b) Reinforcement in y-direction

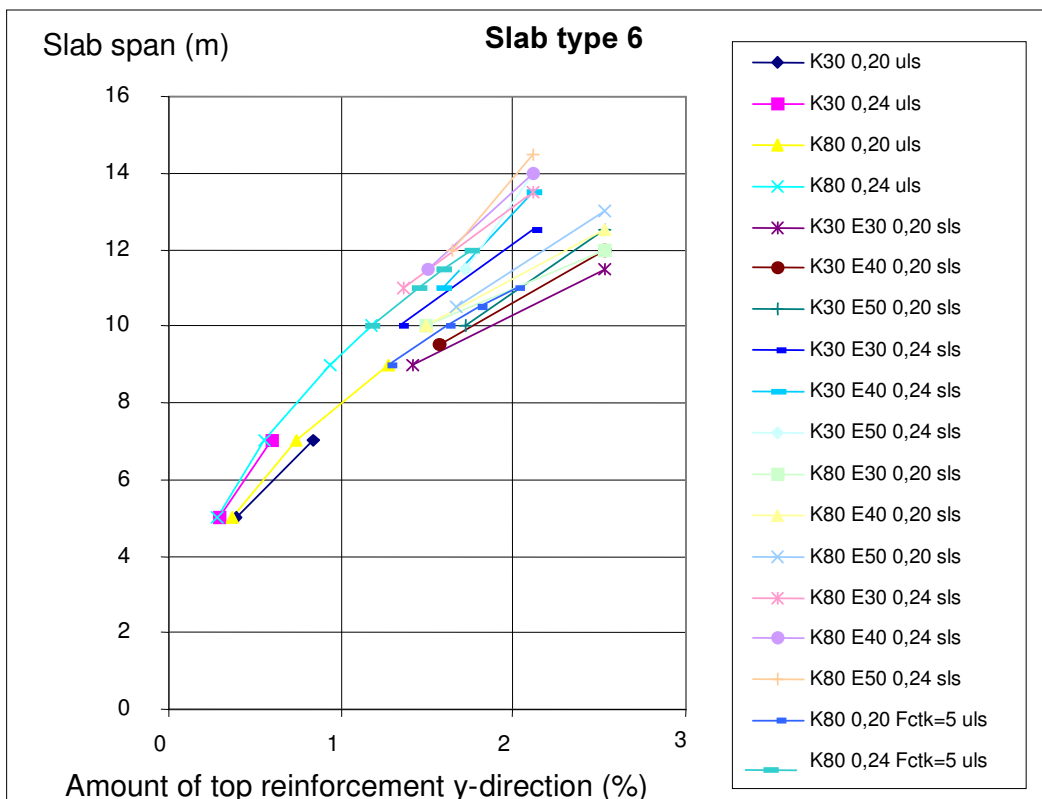

## Result tables

### Explanations

|       |  |
|-------|--|
| B     | Amount of bottom reinforcement (%)   |
| T     | Amount of top reinforcement (%)  |
| x     | Amount in x-direction (%)  |
| y     | Amount in y-direction (%)  |
| Uls   | Maximum allowed slab span when regard is taken to the ultimate limit state       |
| Sls   | Maximum allowed slab span when regard is taken to the serviceability limit state |
| 0,20  | Slab thickness 0,20 m  |
| 0,24  | Slab thickness 0,24 m  |
| K     | Concrete strength class (K-value)  |
| E     | Elastic modulus  |
| bal R | Balanced reinforcement   |

| Strength class / thickness | Ultimate limit state |                |                   |                |            | Serviceability limit state (L/400) |                |                   |                |                |            |
|----------------------------|----------------------|----------------|-------------------|----------------|------------|------------------------------------|----------------|-------------------|----------------|----------------|------------|
|                            | Bottom reinforcement |                | Top reinforcement |                | Max span   | Bottom reinforcement               |                | Top reinforcement |                | Max span       |            |
| <b>Slab 1</b>              |                      |                |                   |                |            |                                    |                |                   |                |                |            |
| <b>K30 0,20</b>            | <b>B x (%)</b>       | <b>B y (%)</b> | <b>T x (%)</b>    | <b>T y (%)</b> | <b>Uls</b> | <b>K30 0,20</b>                    | <b>B x (%)</b> | <b>B y (%)</b>    | <b>T x (%)</b> | <b>T y (%)</b> | <b>Sls</b> |
| bal R 1,89 %               | 0,111                |                | 0,000             |                |            | 4,0                                | 0,259          |                   |                |                | 6,0        |
|                            | 0,216                |                | 0,000             |                |            | 5,5                                | 0,524          |                   |                |                | 6,0        |
|                            | 0,259                |                | 0,000             |                |            | 6,0                                | <b>B x (%)</b> | <b>B y (%)</b>    | <b>T x (%)</b> | <b>T y (%)</b> | <b>Sls</b> |
|                            | 0,306                |                | 0,000             |                |            | 6,5                                | 0,259          |                   |                |                | 6,0        |
|                            | 0,359                |                | 0,000             |                |            | 7,0                                | 0,524          |                   |                |                | 6,5        |
|                            | 0,416                |                | 0,000             |                |            | 7,5                                | <b>B x (%)</b> | <b>B y (%)</b>    | <b>T x (%)</b> | <b>T y (%)</b> | <b>Sls</b> |
|                            | 0,478                |                | 0,000             |                |            | 8,0                                | 0,306          |                   |                |                | 6,5        |
|                            | 0,547                |                | 0,000             |                |            | 8,5                                | 0,524          |                   |                |                | 7,0        |
|                            | 0,799                |                | 0,000             |                |            | 10,0                               |                |                   |                |                |            |
|                            | 1,277                |                | 0,000             |                |            | 12,0                               |                |                   |                |                |            |
|                            | 2,206                |                | 0,873             |                |            | 16,0                               |                |                   |                |                |            |
| <b>K30 0,24</b>            | <b>B x (%)</b>       | <b>B y (%)</b> | <b>T x (%)</b>    | <b>T y (%)</b> | <b>Uls</b> | <b>K30 0,24</b>                    | <b>B x (%)</b> | <b>B y (%)</b>    | <b>T x (%)</b> | <b>T y (%)</b> | <b>Sls</b> |
| bal R 1,89 %               | 0,084                |                | 0,000             |                |            | 4,0                                | 0,229          |                   |                |                | 6,5        |
|                            | 0,162                |                | 0,000             |                |            | 5,5                                | 1,895          |                   |                |                | 8,5        |
|                            | 0,229                |                | 0,000             |                |            | 6,5                                | <b>B x (%)</b> | <b>B y (%)</b>    | <b>T x (%)</b> | <b>T y (%)</b> | <b>Sls</b> |
|                            | 0,269                |                | 0,000             |                |            | 7,0                                | 0,269          |                   |                |                | 7,0        |
|                            | 0,310                |                | 0,000             |                |            | 7,5                                | 1,895          |                   |                |                | 9,0        |
|                            | 0,355                |                | 0,000             |                |            | 8,0                                | <b>B x (%)</b> | <b>B y (%)</b>    | <b>T x (%)</b> | <b>T y (%)</b> | <b>Sls</b> |
|                            | 0,404                |                | 0,000             |                |            | 8,5                                | 0,310          |                   |                |                | 7,5        |
|                            | 0,579                |                | 0,000             |                |            | 10,0                               | 1,895          |                   |                |                | 9,5        |
|                            | 0,720                |                | 0,000             |                |            | 11,0                               |                |                   |                |                |            |
|                            | 0,888                |                | 0,000             |                |            | 12,0                               |                |                   |                |                |            |
|                            | 1,085                |                | 0,000             |                |            | 13,0                               |                |                   |                |                |            |
|                            | 1,693                |                | 0,321             |                |            | 16,0                               |                |                   |                |                |            |
|                            | 2,103                |                | 0,730             |                |            | 18,0                               |                |                   |                |                |            |

| <b>K80 0,20</b> | <b>B x (%)</b>  | <b>B y (%)</b> | <b>T x (%)</b> | <b>T y (%)</b> | <b>UlsK80 0,20</b> | <b>B x (%)</b>     | <b>B y (%)</b> | <b>T x (%)</b> | <b>T y (%)</b> | <b>SlsK80E30 0,20</b> |
|-----------------|-----------------|----------------|----------------|----------------|--------------------|--------------------|----------------|----------------|----------------|-----------------------|
| bal R 4,55 %    | 0,100           |                | 0,000          |                | 4,0                | 0,251              |                |                |                | 6,0                   |
|                 | 0,210           |                | 0,000          |                | 5,5                | 0,524              |                |                |                | 6,5                   |
|                 | 0,251           |                | 0,000          |                | 6,0                | <b>B x (%)</b>     | <b>B y (%)</b> | <b>T x (%)</b> | <b>T y (%)</b> | <b>SlsK80E40 0,20</b> |
|                 | 0,295           |                | 0,000          |                | 6,5                | 0,295              |                |                |                | 6,5                   |
|                 | 0,344           |                | 0,000          |                | 7,0                | 0,524              |                |                |                | 7,0                   |
|                 | 0,396           |                | 0,000          |                | 7,5                | <b>B x (%)</b>     | <b>B y (%)</b> | <b>T x (%)</b> | <b>T y (%)</b> | <b>SlsK80E50 0,20</b> |
|                 | 0,451           |                | 0,000          |                | 8,0                | 0,344              |                |                |                | 7,0                   |
|                 | 0,512           |                | 0,000          |                | 8,5                | 0,524              |                |                |                | 7,5                   |
|                 | 0,719           |                | 0,000          |                | 10,0               |                    |                |                |                |                       |
|                 | 1,061           |                | 0,000          |                | 12,0               |                    |                |                |                |                       |
|                 | 2,012           |                | 0,000          |                | 16,0               |                    |                |                |                |                       |
|                 | 3,552           |                | 0,050          |                | 20,0               |                    |                |                |                |                       |
|                 | 5,403           |                | 1,901          |                | 25,0               |                    |                |                |                |                       |
|                 | <b>K80 0,24</b> | <b>B x (%)</b> | <b>B y (%)</b> | <b>T x (%)</b> | <b>T y (%)</b>     | <b>UlsK80 0,24</b> | <b>B x (%)</b> | <b>B y (%)</b> | <b>T x (%)</b> | <b>T y (%)</b>        |
| bal R 4,55 %    | 0,083           |                | 0,000          |                | 4,0                | 0,258              |                |                |                | 7,0                   |
|                 | 0,159           |                | 0,000          |                | 5,5                | 4,602              |                |                |                | 9,5                   |
|                 | 0,223           |                | 0,000          |                | 6,5                | <b>B x (%)</b>     | <b>B y (%)</b> | <b>T x (%)</b> | <b>T y (%)</b> | <b>SlsK80E40 0,24</b> |
|                 | 0,258           |                | 0,000          |                | 7,0                | 0,297              |                |                |                | 7,5                   |
|                 | 0,297           |                | 0,000          |                | 7,5                | 4,602              |                |                |                | 10,0                  |
|                 | 0,338           |                | 0,000          |                | 8,0                | <b>B x (%)</b>     | <b>B y (%)</b> | <b>T x (%)</b> | <b>T y (%)</b> | <b>SlsK80E50 0,24</b> |
|                 | 0,383           |                | 0,000          |                | 8,5                | 0,338              |                |                |                | 8,0                   |
|                 | 0,778           |                | 0,000          |                | 12,0               | 4,602              |                |                |                | 10,5                  |
|                 | 1,462           |                | 0,000          |                | 16,0               |                    |                |                |                |                       |
|                 | 1,914           |                | 0,000          |                | 18,0               |                    |                |                |                |                       |
|                 | 2,470           |                | 0,000          |                | 20,0               |                    |                |                |                |                       |
|                 | 4,163           |                | 0,557          |                | 25,0               |                    |                |                |                |                       |

**Slab 2**

| <b>K30 0,20</b> | <b>B x (%)</b> | <b>B y (%)</b> | <b>T x (%)</b> | <b>T y (%)</b> | <b>UlsK30 0,20</b> | <b>B x (%)</b> | <b>B y (%)</b> | <b>T x (%)</b> | <b>T y (%)</b> | <b>SlsK30E30 0,20</b> |
|-----------------|----------------|----------------|----------------|----------------|--------------------|----------------|----------------|----------------|----------------|-----------------------|
| bal R 1,89 %    | 0,062          | 0,066          | 0,054          | 0,057          | 5,5                | 0,229          | 0,245          | 0,194          | 0,207          | 9,5                   |
|                 | 0,122          | 0,130          | 0,104          | 0,111          | 7,0                | 2,545          | 2,545          | 2,545          | 2,545          | 10,5                  |
|                 | 0,205          | 0,219          | 0,173          | 0,185          | 9,0                | <b>B x (%)</b> | <b>B y (%)</b> | <b>T x (%)</b> | <b>T y (%)</b> | <b>SlsK30E40 0,20</b> |
|                 | 0,229          | 0,245          | 0,194          | 0,207          | 9,5                | 0,255          | 0,273          | 0,215          | 0,230          | 10,0                  |
|                 | 0,255          | 0,273          | 0,215          | 0,230          | 10,0               | 2,545          | 2,545          | 2,545          | 2,545          | 11,0                  |
|                 | 0,283          | 0,302          | 0,238          | 0,255          | 10,5               | <b>B x (%)</b> | <b>B y (%)</b> | <b>T x (%)</b> | <b>T y (%)</b> | <b>SlsK30E50 0,20</b> |
|                 | 0,312          | 0,334          | 0,262          | 0,281          | 11,0               | 0,283          | 0,302          | 0,238          | 0,255          | 10,5                  |
|                 | 0,447          | 0,481          | 0,373          | 0,400          | 13,0               | 2,545          | 2,545          | 2,545          | 2,545          | 11,5                  |
|                 | 0,713          | 0,777          | 0,587          | 0,634          | 16,0               |                |                |                |                |                       |
|                 | 1,941          | 2,1285         | 1,646          | 1,784          | 25,0               |                |                |                |                |                       |

| <b>K30 0,24</b> | <b>B x (%)</b>  | <b>B y (%)</b> | <b>T x (%)</b> | <b>T y (%)</b> | <b>UlsK30 0,24</b> | <b>B x (%)</b>     | <b>B y (%)</b> | <b>T x (%)</b> | <b>T y (%)</b> | <b>SlsK30E30 0,24</b> |                       |
|-----------------|-----------------|----------------|----------------|----------------|--------------------|--------------------|----------------|----------------|----------------|-----------------------|-----------------------|
| bal R 1,89 %    | 0,047           | 0,049          | 0,041          | 0,043          | 5,5                | 0,212              | 0,223          | 0,180          | 0,189          | 10,5                  |                       |
|                 | 0,092           | 0,097          | 0,079          | 0,083          | 7,0                | 2,120              | 2,120          | 2,120          | 2,120          | 12,0                  |                       |
|                 | 0,121           | 0,128          | 0,103          | 0,109          | 8,0                | <b>B x (%)</b>     | <b>B y (%)</b> | <b>T x (%)</b> | <b>T y (%)</b> | <b>SlsK30E40 0,24</b> |                       |
|                 | 0,154           | 0,163          | 0,131          | 0,138          | 9,0                | 0,256              | 0,270          | 0,216          | 0,228          | 11,5                  |                       |
|                 | 0,192           | 0,202          | 0,163          | 0,171          | 10,0               | 2,120              | 2,120          | 2,120          | 2,120          | 12,5                  |                       |
|                 | 0,212           | 0,223          | 0,180          | 0,189          | 10,5               | <b>B x (%)</b>     | <b>B y (%)</b> | <b>T x (%)</b> | <b>T y (%)</b> | <b>SlsK30E50 0,24</b> |                       |
|                 | 0,233           | 0,246          | 0,198          | 0,208          | 11,0               | 0,280              | 0,296          | 0,237          | 0,250          | 12,0                  |                       |
|                 | 0,256           | 0,270          | 0,216          | 0,228          | 11,5               | 2,120              | 2,120          | 2,120          | 2,120          | 13,0                  |                       |
|                 | 0,280           | 0,296          | 0,237          | 0,250          | 12,0               |                    |                |                |                |                       |                       |
|                 | 0,332           | 0,351          | 0,279          | 0,295          | 13,0               |                    |                |                |                |                       |                       |
|                 | 0,389           | 0,412          | 0,326          | 0,345          | 14,0               |                    |                |                |                |                       |                       |
|                 | 0,521           | 0,553          | 0,433          | 0,459          | 16,0               |                    |                |                |                |                       |                       |
|                 | 0,680           | 0,727          | 0,561          | 0,597          | 18,0               |                    |                |                |                |                       |                       |
|                 | 2,092           | 2,244          | 1,780          | 1,894          | 30,0               |                    |                |                |                |                       |                       |
|                 | <b>K80 0,20</b> | <b>B x (%)</b> | <b>B y (%)</b> | <b>T x (%)</b> | <b>T y (%)</b>     | <b>UlsK80 0,20</b> | <b>B x (%)</b> | <b>B y (%)</b> | <b>T x (%)</b> | <b>T y (%)</b>        | <b>SlsK80E30 0,20</b> |
|                 |                 | 0,062          | 0,065          | 0,053          | 0,057              | 5,5                | 0,248          | 0,264          | 0,210          | 0,224                 | 10,0                  |
| 0,120           |                 | 0,128          | 0,103          | 0,110          | 7,0                | 2,545              | 2,545          | 2,545          | 2,545          | 11,0                  |                       |
| 0,200           |                 | 0,213          | 0,170          | 0,181          | 9,0                | <b>B x (%)</b>     | <b>B y (%)</b> | <b>T x (%)</b> | <b>T y (%)</b> | <b>SlsK80E40 0,20</b> |                       |
| 0,248           |                 | 0,264          | 0,210          | 0,224          | 10,0               | 0,301              | 0,320          | 0,255          | 0,271          | 11,0                  |                       |
| 0,301           |                 | 0,320          | 0,255          | 0,271          | 11,0               | 2,545              | 2,545          | 2,545          | 2,545          | 12,0                  |                       |
| 0,329           |                 | 0,351          | 0,278          | 0,297          | 11,5               | <b>B x (%)</b>     | <b>B y (%)</b> | <b>T x (%)</b> | <b>T y (%)</b> | <b>SlsK80E50 0,20</b> |                       |
| 0,423           |                 | 0,451          | 0,357          | 0,381          | 13,0               | 0,329              | 0,351          | 0,278          | 0,297          | 11,5                  |                       |
| 0,651           |                 | 0,696          | 0,546          | 0,583          | 16,0               | 2,545              | 2,545          | 2,545          | 2,545          | 12,5                  |                       |
| 3,863           |                 | 4,148          | 3,152          | 3,453          | 35,0               |                    |                |                |                |                       |                       |
| <b>K80 0,24</b> |                 | <b>B x (%)</b> | <b>B y (%)</b> | <b>T x (%)</b> | <b>T y (%)</b>     | <b>UlsK80 0,24</b> | <b>B x (%)</b> | <b>B y (%)</b> | <b>T x (%)</b> | <b>T y (%)</b>        | <b>SlsK80E30 0,24</b> |
|                 | 0,047           | 0,049          | 0,041          | 0,043          | 5,5                | 0,249              | 0,262          | 0,211          | 0,222          | 11,5                  |                       |
|                 | 0,092           | 0,096          | 0,079          | 0,083          | 7,0                | 2,120              | 2,120          | 2,120          | 2,120          | 12,5                  |                       |
|                 | 0,120           | 0,125          | 0,103          | 0,108          | 8,0                | <b>B x (%)</b>     | <b>B y (%)</b> | <b>T x (%)</b> | <b>T y (%)</b> | <b>SlsK80E40 0,24</b> |                       |
|                 | 0,152           | 0,159          | 0,130          | 0,136          | 9,0                | 0,272              | 0,285          | 0,230          | 0,243          | 12                    |                       |
|                 | 0,188           | 0,197          | 0,160          | 0,168          | 10,0               | 2,120              | 2,120          | 2,120          | 2,120          | 13,0                  |                       |
|                 | 0,207           | 0,218          | 0,176          | 0,185          | 10,5               | <b>B x (%)</b>     | <b>B y (%)</b> | <b>T x (%)</b> | <b>T y (%)</b> | <b>SlsK80E50 0,24</b> |                       |
|                 | 0,228           | 0,239          | 0,193          | 0,203          | 11,0               | 0,320              | 0,336          | 0,271          | 0,285          | 13,0                  |                       |
|                 | 0,249           | 0,262          | 0,211          | 0,222          | 11,5               | 2,120              | 2,120          | 2,120          | 2,120          | 14                    |                       |
|                 | 0,272           | 0,285          | 0,230          | 0,243          | 12,0               |                    |                |                |                |                       |                       |
|                 | 0,320           | 0,336          | 0,271          | 0,285          | 13,0               |                    |                |                |                |                       |                       |
|                 | 0,372           | 0,392          | 0,314          | 0,331          | 14,0               |                    |                |                |                |                       |                       |
|                 | 0,490           | 0,516          | 0,413          | 0,434          | 16,0               |                    |                |                |                |                       |                       |
|                 | 0,625           | 0,660          | 0,525          | 0,553          | 18,0               |                    |                |                |                |                       |                       |
|                 | 2,771           | 3,000          | 2,223          | 2,387          | 35,0               |                    |                |                |                |                       |                       |

Slab 3

| K30 0,20     | B x (%) | B y (%) | T x (%) | T y (%) | UlsK30 0,20 | B x (%) | B y (%)        | T x (%)        | T y (%)        | SisK30E30 0,20 |                       |
|--------------|---------|---------|---------|---------|-------------|---------|----------------|----------------|----------------|----------------|-----------------------|
| bal R 1,89 % | 0,044   | 0,046   | 0,095   | 0,101   |             | 6,0     | 0,245          | 0,262          | 0,556          | 0,604          | 14,0                  |
|              | 0,078   | 0,083   | 0,170   | 0,182   |             | 8,0     | 0,707          | 0,744          | 1,674          | 1,818          | 15,0                  |
|              | 0,122   | 0,130   | 0,270   | 0,291   |             | 10,0    | <b>B x (%)</b> | <b>B y (%)</b> | <b>T x (%)</b> | <b>T y (%)</b> | <b>SisK30E40 0,20</b> |
|              | 0,178   | 0,189   | 0,398   | 0,429   |             | 12,0    | 0,283          | 0,3025         | 0,645          | 0,708          | 15,0                  |
|              | 0,245   | 0,262   | 0,556   | 0,604   |             | 14,0    | 0,707          | 0,744          | 1,674          | 1,818          | 16,0                  |
|              | 0,283   | 0,303   | 0,645   | 0,708   |             | 15,0    | <b>B x (%)</b> | <b>B y (%)</b> | <b>T x (%)</b> | <b>T y (%)</b> | <b>SisK30E50 0,20</b> |
|              | 0,324   | 0,348   | 0,752   | 0,824   |             | 16,0    | 0,324          | 0,3475         | 0,752          | 0,824          | 16,0                  |
|              | 0,417   | 0,449   | 1,002   | 1,107   |             | 18,0    | 0,707          | 0,744          | 1,674          | 1,818          | 17,0                  |
|              | 0,526   | 0,567   | 1,321   | 1,410   |             | 20,0    |                |                |                |                |                       |
|              | 2,315   | 2,563   | 4,641   | 5,294   |             | 40,0    |                |                |                |                |                       |
| K30 0,24     | B x (%) | B y (%) | T x (%) | T y (%) | UlsK30 0,24 | B x (%) | B y (%)        | T x (%)        | T y (%)        | SisK30E30 0,24 |                       |
| bal R 1,89 % | 0,033   | 0,035   | 0,071   | 0,075   |             | 6,0     | 0,243          | 0,25625        | 0,551          | 0,590          | 16,0                  |
|              | 0,059   | 0,062   | 0,128   | 0,136   |             | 8,0     | 0,589          | 0,62           | 1,395          | 1,515          | 17,0                  |
|              | 0,092   | 0,097   | 0,203   | 0,215   |             | 10,0    | <b>B x (%)</b> | <b>B y (%)</b> | <b>T x (%)</b> | <b>T y (%)</b> | <b>SisK30E40 0,24</b> |
|              | 0,134   | 0,141   | 0,298   | 0,316   |             | 12,0    | 0,276          | 0,29125        | 0,633          | 0,676          | 17,0                  |
|              | 0,184   | 0,194   | 0,413   | 0,439   |             | 14,0    | 0,589          | 0,62           | 1,395          | 1,515          | 18,0                  |
|              | 0,243   | 0,256   | 0,551   | 0,590   |             | 16,0    | <b>B x (%)</b> | <b>B y (%)</b> | <b>T x (%)</b> | <b>T y (%)</b> | <b>SisK30E50 0,24</b> |
|              | 0,276   | 0,291   | 0,633   | 0,676   |             | 17,0    | 0,311          | 0,32875        | 0,721          | 0,773          | 18,0                  |
|              | 0,311   | 0,329   | 0,721   | 0,773   |             | 18,0    | 0,589          | 0,62           | 1,395          | 1,515          | 19,0                  |
|              | 0,390   | 0,413   | 0,923   | 0,998   |             | 20,0    |                |                |                |                |                       |
|              | 1,809   | 1,926   | 3,568   | 3,906   |             | 40,0    |                |                |                |                |                       |
| K80 0,20     | B x (%) | B y (%) | T x (%) | T y (%) | UlsK80 0,20 | B x (%) | B y (%)        | T x (%)        | T y (%)        | SisK80E30 0,20 |                       |
|              | 0,044   | 0,046   | 0,093   | 0,100   |             | 6,0     | 0,274          | 0,2915         | 0,598          | 0,642          | 15,0                  |
|              | 0,077   | 0,082   | 0,167   | 0,178   |             | 8,0     | 0,707          | 0,744          | 1,674          | 1,818          | 16                    |
|              | 0,121   | 0,128   | 0,263   | 0,280   |             | 10,0    | <b>B x (%)</b> | <b>B y (%)</b> | <b>T x (%)</b> | <b>T y (%)</b> | <b>SisK80E40 0,20</b> |
|              | 0,174   | 0,185   | 0,379   | 0,406   |             | 12,0    | 0,312          | 0,332          | 0,685          | 0,734          | 16                    |
|              | 0,238   | 0,253   | 0,517   | 0,556   |             | 14,0    | 0,707          | 0,744          | 1,674          | 1,818          | 17,0                  |
|              | 0,274   | 0,292   | 0,598   | 0,642   |             | 15,0    | <b>B x (%)</b> | <b>B y (%)</b> | <b>T x (%)</b> | <b>T y (%)</b> | <b>SisK80E50 0,20</b> |
|              | 0,312   | 0,332   | 0,685   | 0,734   |             | 16,0    | 0,354          | 0,3765         | 0,777          | 0,833          | 17,0                  |
|              | 0,354   | 0,377   | 0,777   | 0,833   |             | 17,0    | 0,707          | 0,744          | 1,674          | 1,818          | 18                    |
|              | 0,397   | 0,424   | 0,871   | 0,938   |             | 18,0    |                |                |                |                |                       |
|              | 0,493   | 0,527   | 1,091   | 1,174   |             | 20,0    |                |                |                |                |                       |
| 2,151        | 2,342   | 4,822   | 5,279   | 40,0    |             |         |                |                |                |                |                       |
| K80 0,24     | B x (%) | B y (%) | T x (%) | T y (%) | UlsK80 0,24 | B x (%) | B y (%)        | T x (%)        | T y (%)        | SisK80E30 0,24 |                       |
|              | 0,033   | 0,035   | 0,071   | 0,075   |             | 6,0     | 0,268          | 0,282          | 0,586          | 0,620          | 17,0                  |
|              | 0,059   | 0,062   | 0,127   | 0,134   |             | 8,0     | 0,589          | 0,620          | 1,395          | 1,515          | 18                    |
|              | 0,092   | 0,096   | 0,199   | 0,210   |             | 10,0    | <b>B x (%)</b> | <b>B y (%)</b> | <b>T x (%)</b> | <b>T y (%)</b> | <b>SisK80E40 0,24</b> |
|              | 0,132   | 0,139   | 0,287   | 0,304   |             | 12,0    | 0,300          | 0,316          | 0,659          | 0,696          | 18                    |
|              | 0,180   | 0,190   | 0,394   | 0,416   |             | 14,0    | 0,589          | 0,620          | 1,395          | 1,515          | 19,0                  |
|              | 0,236   | 0,249   | 0,518   | 0,547   |             | 16,0    | <b>B x (%)</b> | <b>B y (%)</b> | <b>T x (%)</b> | <b>T y (%)</b> | <b>SisK80E50 0,24</b> |
|              | 0,268   | 0,282   | 0,586   | 0,620   |             | 17,0    | 0,354          | 0,372          | 0,775          | 0,823          | 19,5                  |
|              | 0,300   | 0,316   | 0,659   | 0,696   |             | 18,0    | 0,589          | 0,620          | 1,395          | 1,515          | 20                    |
|              | 0,354   | 0,372   | 0,775   | 0,823   |             | 19,5    |                |                |                |                |                       |
|              | 0,373   | 0,392   | 0,819   | 0,868   |             | 20,0    |                |                |                |                |                       |
| 1,861        | 1,999   | 4,295   | 4,567   | 43,0    |             |         |                |                |                |                |                       |

Slab 4

| <b>K30 0,20</b> | <b>B x (%)</b> | <b>B y (%)</b> | <b>T x (%)</b> | <b>T y (%)</b> | <b>UlsK30 0,20</b> | <b>B x (%)</b> | <b>B y (%)</b> | <b>T x (%)</b> | <b>T y (%)</b> | <b>SlsK30E30 0,20</b> |
|-----------------|----------------|----------------|----------------|----------------|--------------------|----------------|----------------|----------------|----------------|-----------------------|
|                 | 0,093          | 0,128          | 0,439          | 0,432          | 5,0                | 0,259          | 0,3395         | 1,067          | 1,031          | 8,0                   |
|                 | 0,137          | 0,186          | 0,590          | 0,572          | 6,0                | 0,778          | 0,987          | 2,957          | 2,821          | 9,0                   |
|                 | 0,224          | 0,296          | 0,966          | 0,953          | 7,5                | <b>B x (%)</b> | <b>B y (%)</b> | <b>T x (%)</b> | <b>T y (%)</b> | <b>SlsK30E40 0,20</b> |
|                 | 0,259          | 0,340          | 1,067          | 1,031          | 8,0                | 0,295          | 0,387          | 1,223          | 1,177          | 8,5                   |
|                 | 0,295          | 0,387          | 1,223          | 1,177          | 8,5                | 0,778          | 0,987          | 2,957          | 2,821          | 9,5                   |
|                 | 0,340          | 0,438          | 1,396          | 1,367          | 9,0                | <b>B x (%)</b> | <b>B y (%)</b> | <b>T x (%)</b> | <b>T y (%)</b> | <b>SlsK30E50 0,20</b> |
|                 | 0,432          | 0,554          | 1,618          | 1,563          | 10,0               | 0,340          | 0,438          | 1,396          | 1,367          | 9,0                   |
|                 | 0,548          | 0,691          | 1,879          | 1,824          | 11,0               | 0,778          | 0,987          | 2,957          | 2,821          | 10,0                  |
|                 | 1,267          | 1,466          | 3,081          | 2,997          | 15,0               |                |                |                |                |                       |
| <b>K30 0,24</b> | <b>B x (%)</b> | <b>B y (%)</b> | <b>T x (%)</b> | <b>T y (%)</b> | <b>UlsK30 0,24</b> | <b>B x (%)</b> | <b>B y (%)</b> | <b>T x (%)</b> | <b>T y (%)</b> | <b>SlsK30E30 0,24</b> |
|                 | 0,070          | 0,096          | 0,321          | 0,306          | 5,0                | 0,245          | 0,322          | 1,034          | 0,980          | 9,0                   |
|                 | 0,102          | 0,138          | 0,456          | 0,436          | 6,0                | 0,648          | 0,823          | 2,464          | 2,351          | 10,5                  |
|                 | 0,164          | 0,219          | 0,708          | 0,675          | 7,5                | <b>B x (%)</b> | <b>B y (%)</b> | <b>T x (%)</b> | <b>T y (%)</b> | <b>SlsK30E40 0,24</b> |
|                 | 0,245          | 0,322          | 1,034          | 0,980          | 9,0                | 0,276          | 0,361          | 1,164          | 1,101          | 9,5                   |
|                 | 0,276          | 0,361          | 1,164          | 1,101          | 9,5                | 0,648          | 0,823          | 2,464          | 2,351          | 11,0                  |
|                 | 0,310          | 0,403          | 1,311          | 1,237          | 10,0               | <b>B x (%)</b> | <b>B y (%)</b> | <b>T x (%)</b> | <b>T y (%)</b> | <b>SlsK30E50 0,24</b> |
|                 | 0,387          | 0,497          | 1,536          | 1,458          | 11,0               | 0,310          | 0,403          | 1,311          | 1,237          | 10,0                  |
|                 | 0,430          | 0,548          | 1,643          | 1,563          | 11,5               | 0,648          | 0,823          | 2,464          | 2,351          | 11,0                  |
|                 | 0,843          | 1,036          | 2,470          | 2,356          | 15,0               |                |                |                |                |                       |
| <b>K80 0,20</b> | <b>B x (%)</b> | <b>B y (%)</b> | <b>T x (%)</b> | <b>T y (%)</b> | <b>UlsK80 0,20</b> | <b>B x (%)</b> | <b>B y (%)</b> | <b>T x (%)</b> | <b>T y (%)</b> | <b>SlsK80E30 0,20</b> |
| fctk=5          | 0,092          | 0,126          | 0,416          | 0,408          | 5,0                | 0,287          | 0,369          | 1,025          | 0,981          | 8,5                   |
|                 | 0,135          | 0,182          | 0,548          | 0,525          | 6,0                | 0,778          | 0,987          | 2,957          | 2,821          | 9,5                   |
|                 | 0,219          | 0,286          | 0,846          | 0,828          | 7,5                | <b>B x (%)</b> | <b>B y (%)</b> | <b>T x (%)</b> | <b>T y (%)</b> | <b>SlsK80E40 0,20</b> |
|                 | 0,287          | 0,369          | 1,025          | 0,981          | 8,5                | 0,327          | 0,415          | 1,159          | 1,132          | 9                     |
|                 | 0,327          | 0,415          | 1,159          | 1,132          | 9,0                | 0,778          | 0,987          | 2,957          | 2,821          | 10,0                  |
|                 | 0,370          | 0,463          | 1,273          | 1,242          | 9,5                | <b>B x (%)</b> | <b>B y (%)</b> | <b>T x (%)</b> | <b>T y (%)</b> | <b>SlsK80E50 0,20</b> |
|                 | 0,413          | 0,516          | 1,380          | 1,311          | 10,0               | 0,370          | 0,463          | 1,273          | 1,242          | 9,5                   |
|                 | 0,513          | 0,629          | 1,651          | 1,558          | 11,0               | 0,778          | 0,987          | 2,957          | 2,821          | 11                    |
| 1,055           | 1,224          | 3,118          | 2,851          | 15,0           |                    |                |                |                |                |                       |
| <b>K80 0,24</b> | <b>B x (%)</b> | <b>B y (%)</b> | <b>T x (%)</b> | <b>T y (%)</b> | <b>UlsK80 0,24</b> | <b>B x (%)</b> | <b>B y (%)</b> | <b>T x (%)</b> | <b>T y (%)</b> | <b>SlsK80E30 0,24</b> |
| fctk=5          | 0,070          | 0,095          | 0,309          | 0,293          | 5,0                | 0,268          | 0,346          | 0,993          | 0,939          | 9,5                   |
|                 | 0,101          | 0,137          | 0,432          | 0,411          | 6,0                | 0,648          | 0,823          | 2,464          | 2,351          | 10,5                  |
|                 | 0,161          | 0,214          | 0,648          | 0,616          | 7,5                | <b>B x (%)</b> | <b>B y (%)</b> | <b>T x (%)</b> | <b>T y (%)</b> | <b>SlsK80E40 0,24</b> |
|                 | 0,238          | 0,310          | 0,900          | 0,853          | 9,0                | 0,334          | 0,425          | 1,191          | 1,122          | 10,5                  |
|                 | 0,268          | 0,346          | 0,993          | 0,939          | 9,5                | 0,648          | 0,823          | 2,464          | 2,351          | 11,0                  |
|                 | 0,300          | 0,385          | 1,090          | 1,029          | 10,0               | <b>B x (%)</b> | <b>B y (%)</b> | <b>T x (%)</b> | <b>T y (%)</b> | <b>SlsK80E50 0,24</b> |
|                 | 0,334          | 0,425          | 1,191          | 1,122          | 10,5               | 0,370          | 0,468          | 1,297          | 1,219          | 11,0                  |
|                 | 0,370          | 0,468          | 1,297          | 1,219          | 11,0               | 0,648          | 0,823          | 2,464          | 2,351          | 11,5                  |
| 0,409           | 0,513          | 1,408          | 1,320          | 11,5           |                    |                |                |                |                |                       |
| 0,757           | 0,896          | 2,356          | 2,160          | 15             |                    |                |                |                |                |                       |

Slab 5

| <b>K30 0,20</b> | <b>B x (%)</b> | <b>B y (%)</b> | <b>T x (%)</b> | <b>T y (%)</b> | <b>UlsK30 0,20</b> | <b>B x (%)</b> | <b>B y (%)</b> | <b>T x (%)</b> | <b>T y (%)</b> | <b>SisK30E30 0,20</b> |                       |
|-----------------|----------------|----------------|----------------|----------------|--------------------|----------------|----------------|----------------|----------------|-----------------------|-----------------------|
| bal R 1,89 %    | 0,121          | 0,152          | 0,672          | 0,766          | 5,5                | 0,203          | 0,250          | 1,145          | 1,323          | 7,0                   |                       |
|                 | 0,203          | 0,250          | 1,145          | 1,323          |                    | 7,0            | 1,743          | 2,401          | 4,232          | 4,720                 | 8,5                   |
|                 | 0,236          | 0,289          | 1,347          | 1,498          |                    | 7,5            | <b>B x (%)</b> | <b>B y (%)</b> | <b>T x (%)</b> | <b>T y (%)</b>        | <b>SisK30E40 0,20</b> |
|                 | 0,272          | 0,332          | 1,498          | 1,682          | 8,0                | 0,236          | 0,289          | 1,347          | 1,498          | 7,5                   |                       |
|                 | 0,322          | 0,378          | 1,654          | 1,874          | 8,5                | 1,743          | 2,401          | 4,232          | 4,720          | 9,0                   |                       |
|                 | 0,396          | 0,482          | 1,989          | 2,284          | 9,5                | <b>B x (%)</b> | <b>B y (%)</b> | <b>T x (%)</b> | <b>T y (%)</b> | <b>SisK30E50 0,20</b> |                       |
|                 | 0,551          | 0,671          | 2,542          | 2,963          | 11,0               | 0,272          | 0,332          | 1,498          | 1,682          | 8,0                   |                       |
|                 | 0,674          | 0,826          | 2,945          | 3,458          | 12,0               | 1,743          | 2,401          | 4,232          | 4,720          | 9,5                   |                       |
|                 | 0,985          | 1,232          | 3,833          | 4,550          | 14,0               |                |                |                |                |                       |                       |
| <b>K30 0,24</b> | <b>B x (%)</b> | <b>B y (%)</b> | <b>T x (%)</b> | <b>T y (%)</b> | <b>UlsK30 0,24</b> | <b>B x (%)</b> | <b>B y (%)</b> | <b>T x (%)</b> | <b>T y (%)</b> | <b>SisK30E30 0,24</b> |                       |
| bal R 1,89 %    | 0,090          | 0,114          | 0,509          | 0,564          | 5,5                | 0,201          | 0,245          | 1,142          | 1,312          | 8,0                   |                       |
|                 | 0,175          | 0,215          | 0,984          | 1,120          |                    | 7,5            | 1,453          | 2,000          | 3,526          | 3,933                 | 10,5                  |
|                 | 0,201          | 0,245          | 1,142          | 1,312          | 8,0                | <b>B x (%)</b> | <b>B y (%)</b> | <b>T x (%)</b> | <b>T y (%)</b> | <b>SisK30E40 0,24</b> |                       |
|                 | 0,229          | 0,279          | 1,323          | 1,455          | 8,5                | 0,229          | 0,279          | 1,323          | 1,455          | 8,5                   |                       |
|                 | 0,260          | 0,315          | 1,466          | 1,603          | 9,0                | 1,453          | 2,000          | 3,526          | 3,933          | 11,0                  |                       |
|                 | 0,292          | 0,352          | 1,599          | 1,760          | 9,5                | <b>B x (%)</b> | <b>B y (%)</b> | <b>T x (%)</b> | <b>T y (%)</b> | <b>SisK30E50 0,24</b> |                       |
|                 | 0,327          | 0,394          | 1,734          | 1,919          | 10,0               | 0,260          | 0,315          | 1,466          | 1,603          | 9,0                   |                       |
|                 | 0,403          | 0,485          | 2,021          | 2,259          | 11,0               | 1,453          | 2,000          | 3,526          | 3,933          | 11,0                  |                       |
|                 | 0,490          | 0,588          | 2,329          | 2,623          | 12,0               |                |                |                |                |                       |                       |
| 0,825           | 1,000          | 3,372          | 3,858          | 15,0           |                    |                |                |                |                |                       |                       |
| <b>K80 0,20</b> | <b>B x (%)</b> | <b>B y (%)</b> | <b>T x (%)</b> | <b>T y (%)</b> | <b>UlsK80 0,20</b> | <b>B x (%)</b> | <b>B y (%)</b> | <b>T x (%)</b> | <b>T y (%)</b> | <b>SisK80E30 0,20</b> |                       |
| fctk=5          | 0,120          | 0,150          | 0,617          | 0,686          | 5,5                | 0,230          | 0,280          | 1,111          | 1,251          | 7,5                   |                       |
|                 | 0,230          | 0,280          | 1,111          | 1,251          |                    | 7,5            | 1,743          | 2,401          | 4,232          | 4,720                 | 9                     |
|                 | 0,263          | 0,319          | 1,259          | 1,422          | 8,0                | <b>B x (%)</b> | <b>B y (%)</b> | <b>T x (%)</b> | <b>T y (%)</b> | <b>SisK80E40 0,20</b> |                       |
|                 | 0,299          | 0,361          | 1,417          | 1,606          | 8,5                | 0,263          | 0,319          | 1,259          | 1,422          | 8                     |                       |
|                 | 0,378          | 0,452          | 1,769          | 2,028          | 9,5                | 1,743          | 2,401          | 4,232          | 4,720          | 9,5                   |                       |
|                 | 0,515          | 0,613          | 2,407          | 2,807          | 11,0               | <b>B x (%)</b> | <b>B y (%)</b> | <b>T x (%)</b> | <b>T y (%)</b> | <b>SisK80E50 0,20</b> |                       |
|                 | 0,619          | 0,735          | 2,928          | 3,424          | 12,0               | 0,299          | 0,361          | 1,417          | 1,606          | 8,5                   |                       |
|                 | 0,861          | 1,020          | 3,994          | 4,516          | 15,0               | 1,743          | 2,401          | 4,232          | 4,720          | 10                    |                       |
|                 |                |                |                |                |                    |                |                |                |                |                       |                       |
| <b>K80 0,24</b> | <b>B x (%)</b> | <b>B y (%)</b> | <b>T x (%)</b> | <b>T y (%)</b> | <b>UlsK80 0,24</b> | <b>B x (%)</b> | <b>B y (%)</b> | <b>T x (%)</b> | <b>T y (%)</b> | <b>SisK80E30 0,24</b> |                       |
| fctk=5          | 0,089          | 0,113          | 0,478          | 0,523          | 5,5                | 0,224          | 0,270          | 1,097          | 1,215          | 8,5                   |                       |
|                 | 0,172          | 0,210          | 0,863          | 0,952          |                    | 7,5            | 1,453          | 2,000          | 3,526          | 3,933                 | 10,5                  |
|                 | 0,197          | 0,239          | 0,977          | 1,079          | 8,0                | <b>B x (%)</b> | <b>B y (%)</b> | <b>T x (%)</b> | <b>T y (%)</b> | <b>SisK80E40 0,24</b> |                       |
|                 | 0,224          | 0,270          | 1,097          | 1,215          | 8,5                | 0,283          | 0,338          | 1,362          | 1,518          | 9,5                   |                       |
|                 | 0,252          | 0,303          | 1,225          | 1,360          | 9,0                | 1,453          | 2,000          | 3,526          | 3,933          | 11,0                  |                       |
|                 | 0,283          | 0,338          | 1,362          | 1,518          | 9,5                | <b>B x (%)</b> | <b>B y (%)</b> | <b>T x (%)</b> | <b>T y (%)</b> | <b>SisK80E50 0,24</b> |                       |
|                 | 0,315          | 0,376          | 1,505          | 1,680          | 10,0               | 0,315          | 0,376          | 1,505          | 1,680          | 10,0                  |                       |
|                 | 0,385          | 0,457          | 1,820          | 2,050          | 11,0               | 1,453          | 2,000          | 3,526          | 3,933          | 11,5                  |                       |
|                 | 0,463          | 0,546          | 2,182          | 2,475          | 12,0               |                |                |                |                |                       |                       |
| 0,743           | 0,870          | 3,618          | 3,957          | 15,0           |                    |                |                |                |                |                       |                       |



Slab 6

| <b>K30 0,20</b> | <b>B x (%)</b> | <b>B y (%)</b> | <b>T x (%)</b> | <b>T y (%)</b> | <b>UlsK30 0,20</b> | <b>B x (%)</b> | <b>B y (%)</b> | <b>T x (%)</b> | <b>T y (%)</b> | <b>SisK30E30 0,20</b> |
|-----------------|----------------|----------------|----------------|----------------|--------------------|----------------|----------------|----------------|----------------|-----------------------|
| bal R 1,89 %    | 0,060          | 0,063          | 0,367          | 0,394          | 5,0                | 0,198          | 0,210          | 1,422          | 1,522          | 9,0                   |
|                 | 0,118          | 0,125          | 0,771          | 0,841          | 7,0                | 0,402          | 0,402          | 2,534          | 2,534          | 11,5                  |
|                 | 0,198          | 0,210          | 1,422          | 1,522          | 9,0                | <b>B x (%)</b> | <b>B y (%)</b> | <b>T x (%)</b> | <b>T y (%)</b> | <b>SisK30E40 0,20</b> |
|                 | 0,222          | 0,237          | 1,570          | 1,696          | 9,5                | 0,222          | 0,237          | 1,570          | 1,696          | 9,5                   |
|                 | 0,248          | 0,264          | 1,727          | 1,878          | 10,0               | 0,402          | 0,402          | 2,534          | 2,534          | 12,0                  |
|                 | 0,304          | 0,326          | 2,062          | 2,269          | 11,0               | <b>B x (%)</b> | <b>B y (%)</b> | <b>T x (%)</b> | <b>T y (%)</b> | <b>SisK30E50 0,20</b> |
|                 | 0,440          | 0,473          | 2,822          | 3,156          | 13,0               | 0,248          | 0,264          | 1,727          | 1,878          | 10,0                  |
|                 | 0,610          | 0,662          | 3,700          | 4,181          | 15,0               | 0,402          | 0,402          | 2,534          | 2,534          | 12,5                  |
| <b>K30 0,24</b> | <b>B x (%)</b> | <b>B y (%)</b> | <b>T x (%)</b> | <b>T y (%)</b> | <b>UlsK30 0,24</b> | <b>B x (%)</b> | <b>B y (%)</b> | <b>T x (%)</b> | <b>T y (%)</b> | <b>SisK30E30 0,24</b> |
| bal R 1,89 %    | 0,045          | 0,048          | 0,278          | 0,293          | 5,0                | 0,184          | 0,194          | 1,341          | 1,410          | 10,0                  |
|                 | 0,089          | 0,094          | 0,565          | 0,601          | 7,0                | 0,335          | 0,335          | 2,112          | 2,112          | 12,5                  |
|                 | 0,149          | 0,156          | 1,015          | 1,097          | 9,0                | <b>B x (%)</b> | <b>B y (%)</b> | <b>T x (%)</b> | <b>T y (%)</b> | <b>SisK30E40 0,24</b> |
|                 | 0,184          | 0,194          | 1,341          | 1,410          | 10,0               | 0,225          | 0,238          | 1,598          | 1,688          | 11,0                  |
|                 | 0,225          | 0,238          | 1,598          | 1,688          | 11,0               | 0,335          | 0,335          | 2,112          | 2,112          | 13,5                  |
|                 | 0,247          | 0,261          | 1,728          | 1,834          | 11,5               | <b>B x (%)</b> | <b>B y (%)</b> | <b>T x (%)</b> | <b>T y (%)</b> | <b>SisK30E50 0,24</b> |
|                 | 0,323          | 0,342          | 2,160          | 2,320          | 13,0               | 0,247          | 0,261          | 1,728          | 1,834          | 11,5                  |
|                 | 0,445          | 0,468          | 2,810          | 3,051          | 15,0               | 0,335          | 0,335          | 2,112          | 2,112          | 14,0                  |
| <b>K80 0,20</b> | <b>B x (%)</b> | <b>B y (%)</b> | <b>T x (%)</b> | <b>T y (%)</b> | <b>UlsK80 0,20</b> | <b>B x (%)</b> | <b>B y (%)</b> | <b>T x (%)</b> | <b>T y (%)</b> | <b>SisK80E30 0,20</b> |
| fctk=5          | 0,059          | 0,063          | 0,353          | 0,376          | 5,0                | 0,240          | 0,256          | 1,493          | 1,613          | 10,0                  |
|                 | 0,116          | 0,124          | 0,699          | 0,747          | 7,0                | 0,402          | 0,402          | 2,534          | 2,534          | 12                    |
|                 | 0,193          | 0,205          | 1,186          | 1,276          | 9,0                | <b>B x (%)</b> | <b>B y (%)</b> | <b>T x (%)</b> | <b>T y (%)</b> | <b>SisK80E40 0,20</b> |
|                 | 0,240          | 0,256          | 1,493          | 1,613          | 10,0               | 0,240          | 0,256          | 1,493          | 1,613          | 10                    |
|                 | 0,266          | 0,284          | 1,664          | 1,803          | 10,5               | 0,402          | 0,402          | 2,534          | 2,534          | 12,5                  |
|                 | 0,294          | 0,313          | 1,850          | 2,013          | 11,0               | <b>B x (%)</b> | <b>B y (%)</b> | <b>T x (%)</b> | <b>T y (%)</b> | <b>SisK80E50 0,20</b> |
|                 | 0,400          | 0,445          | 2,767          | 3,067          | 13,0               | 0,266          | 0,284          | 1,664          | 1,803          | 10,5                  |
|                 | 0,566          | 0,605          | 3,864          | 4,149          | 15,0               | 0,402          | 0,402          | 2,534          | 2,534          | 13                    |
| <b>K80 0,24</b> | <b>B x (%)</b> | <b>B y (%)</b> | <b>T x (%)</b> | <b>T y (%)</b> | <b>UlsK80 0,24</b> | <b>B x (%)</b> | <b>B y (%)</b> | <b>T x (%)</b> | <b>T y (%)</b> | <b>SisK80E30 0,24</b> |
| fctk=5          | 0,045          | 0,048          | 0,270          | 0,285          | 5,0                | 0,220          | 0,231          | 1,364          | 1,448          | 11,0                  |
|                 | 0,088          | 0,093          | 0,530          | 0,558          | 7,0                | 0,335          | 0,335          | 2,112          | 2,112          | 13,5                  |
|                 | 0,146          | 0,153          | 0,889          | 0,940          | 9,0                | <b>B x (%)</b> | <b>B y (%)</b> | <b>T x (%)</b> | <b>T y (%)</b> | <b>SisK80E40 0,24</b> |
|                 | 0,180          | 0,190          | 1,110          | 1,176          | 10,0               | 0,241          | 0,254          | 1,500          | 1,596          | 11,5                  |
|                 | 0,220          | 0,231          | 1,364          | 1,448          | 11,0               | 0,335          | 0,335          | 2,112          | 2,112          | 14,0                  |
|                 | 0,241          | 0,254          | 1,500          | 1,596          | 11,5               | <b>B x (%)</b> | <b>B y (%)</b> | <b>T x (%)</b> | <b>T y (%)</b> | <b>SisK80E50 0,24</b> |
|                 | 0,263          | 0,277          | 1,648          | 1,756          | 12,0               | 0,263          | 0,277          | 1,648          | 1,756          | 12,0                  |
|                 | 0,313          | 0,328          | 1,982          | 2,123          | 13,0               | 0,335          | 0,335          | 2,112          | 2,112          | 14,5                  |
| 0,423           | 0,444          | 2,800          | 3,033          | 15,0           |                    |                |                |                |                |                       |

## **Appendix C**

### **Drying of HPC – results**

**Climate 1 Controlled drying directly after casting (summer conditions); see Figure 4.2**

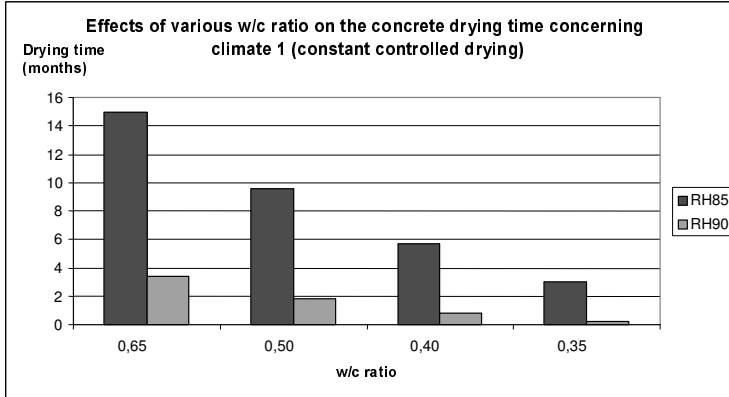

In this Appendix results of calculation of drying time to 85 % RH and 90 % are presented. Variables for each climate are w/c-ratio, slab thickness, form type and use of silica fume.

Filigran-form  
20 cm slab thickness

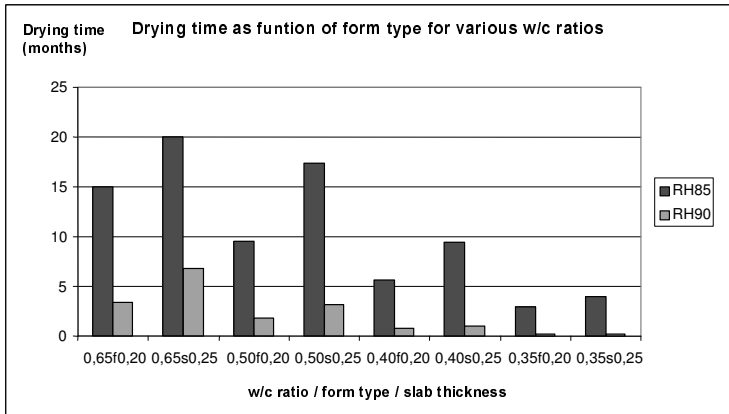

f= Filigran-form  
s= steel form

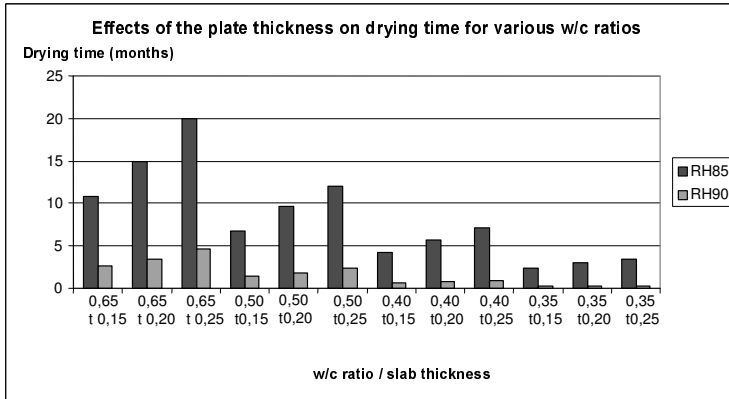

Filigran-form

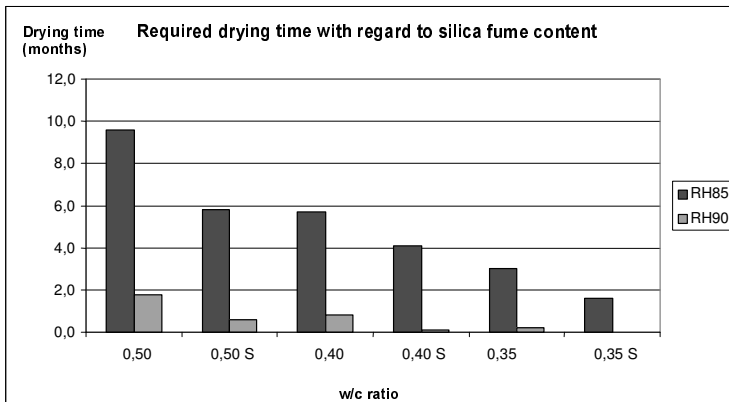

20 cm slab thickness  
S= 5 % silica fume  
Filigran-form  
w/c=water/Portland cement

**Climate 2 Controlled drying after one month (summer conditions); see Figure 4.7**

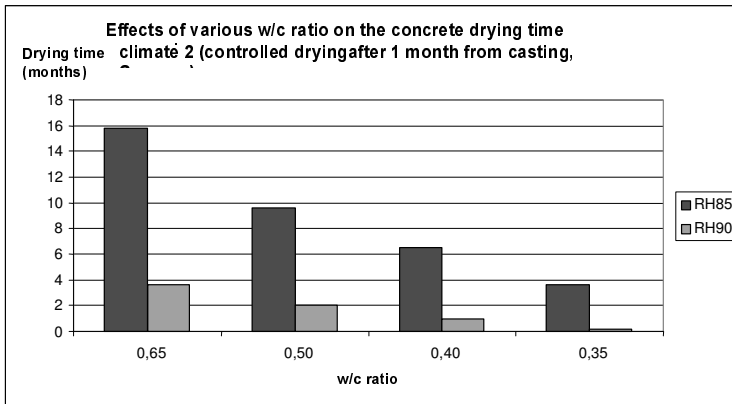

Filigran-form  
 20 cm slab thickness

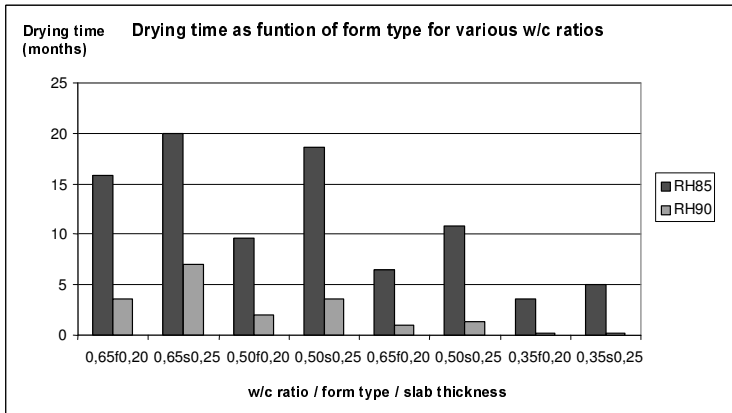

f= Filigran-form  
 s= steel form

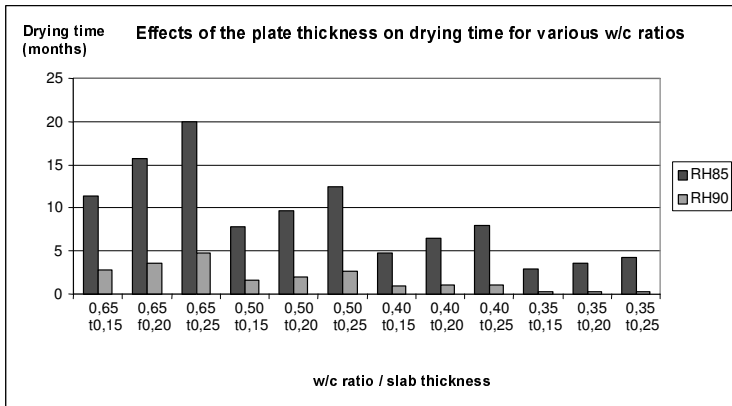

Filigran-form

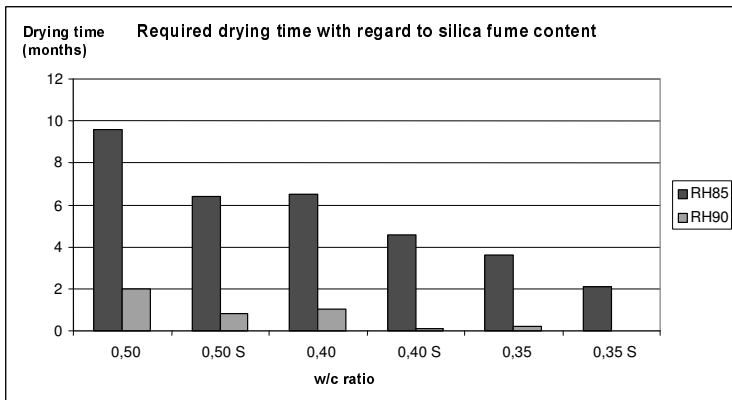

20 cm slab thickness  
 S= 5 % silica fume  
 Filigran-form  
 w/c=water/Portland cement

**Climate 3 controlled drying after 1 month (winter conditions, default temperature data); see Figure 4.9**

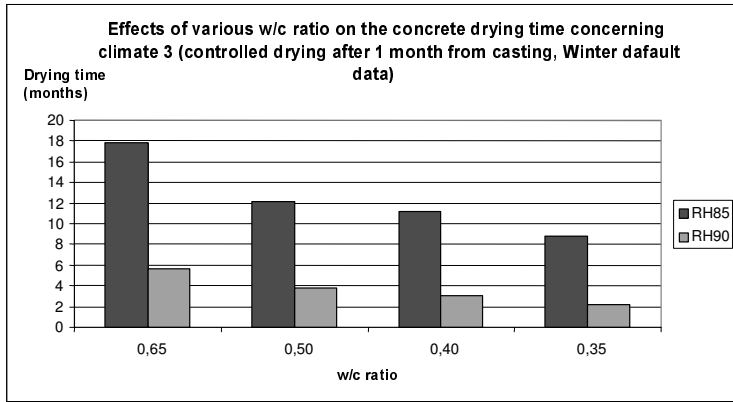

Filigran-form  
20 cm slab thickness

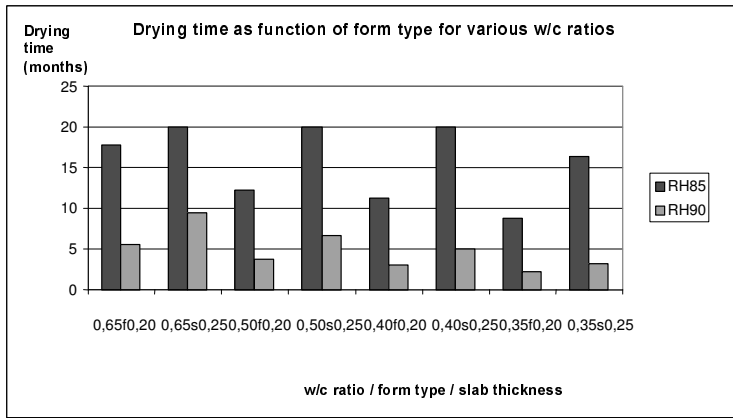

f= Filigran-form  
s= steel form

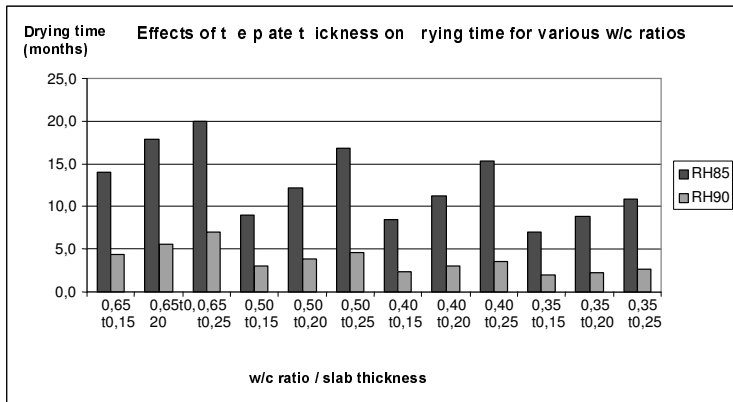

Filigran-form

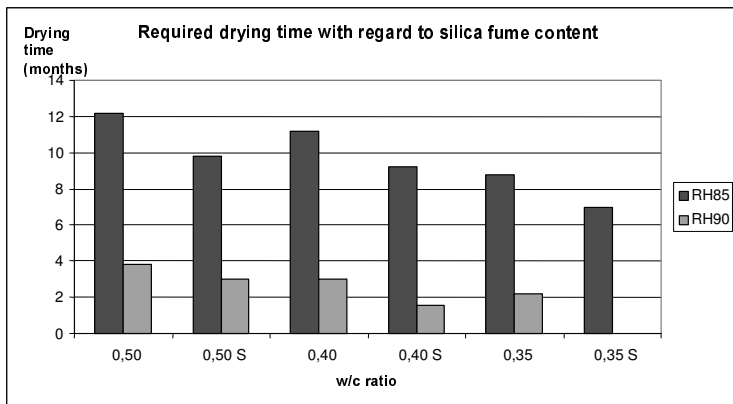

20 cm slab thickness  
S= 5 % silica fume  
Filigran-form  
w/c=water/Portland cement

**Climate 4 controlled drying after 1 month (winter conditions, modified temperature data, 10 °C during the first week after casting); see Figure 4.11**

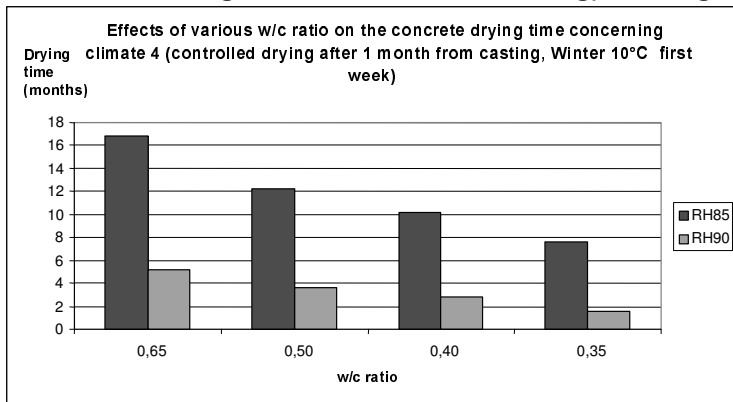

Filigran-form  
20 cm slab thickness

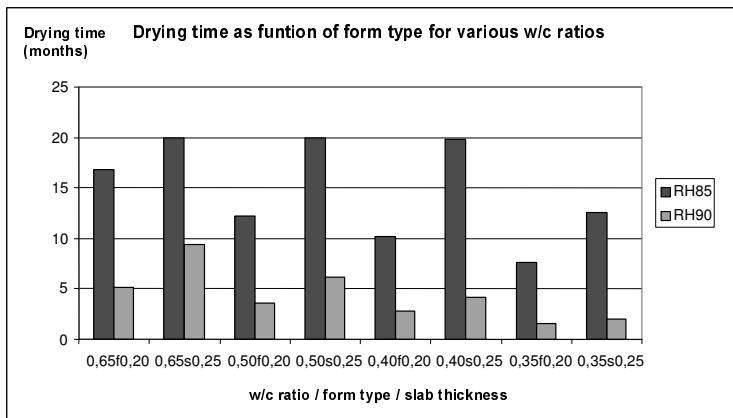

f= Filigran-form  
s= steel form

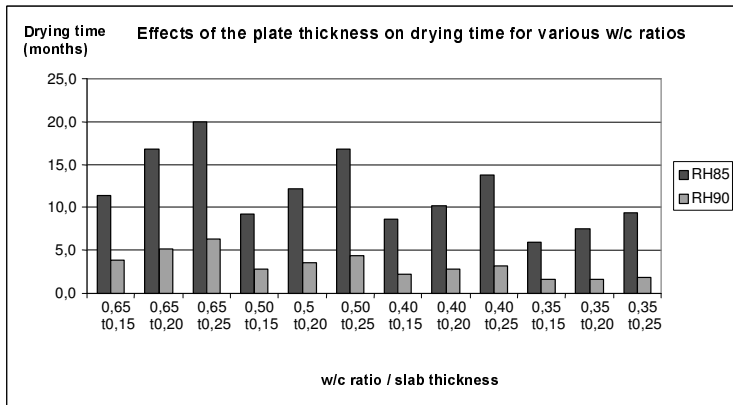

Filigran-form

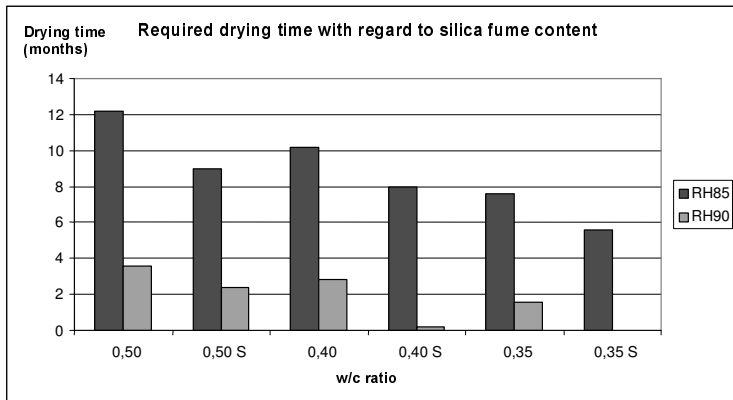

20 cm slab thickness  
S= 5 % silica fume  
Filigran-form  
w/c=water/Portland cement

**Climate 5 controlled drying after 1 month (winter conditions, used concrete temperature data from Hett97 during the first four days after casting); see Figure 4.14**

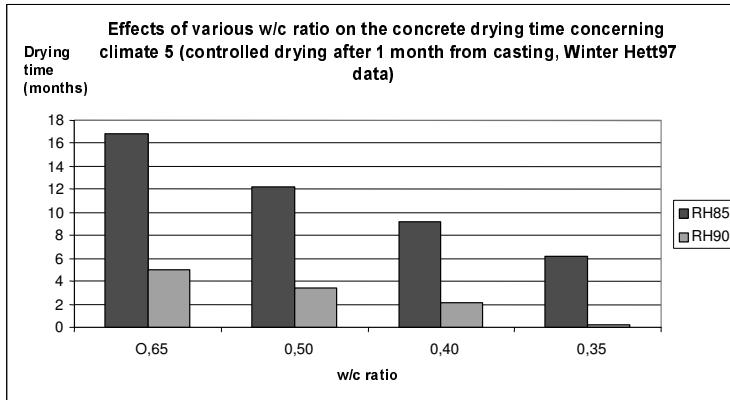

Filigran-form  
20 cm slab thickness

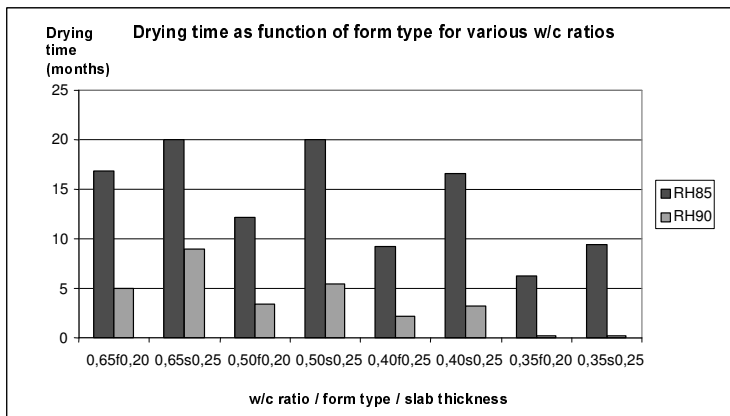

f= Filigran-form  
s= steel form

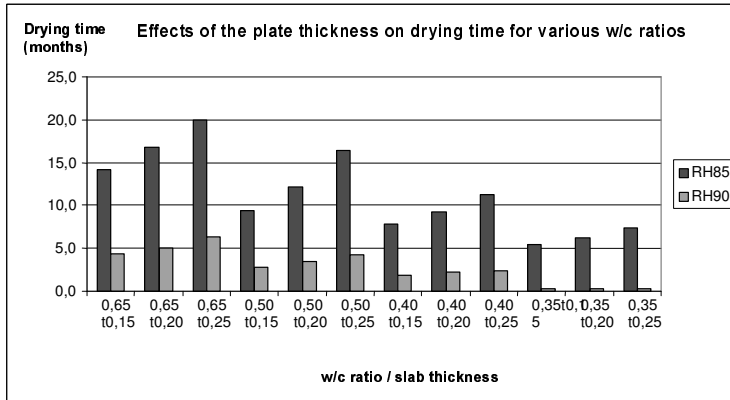

Filigran-form

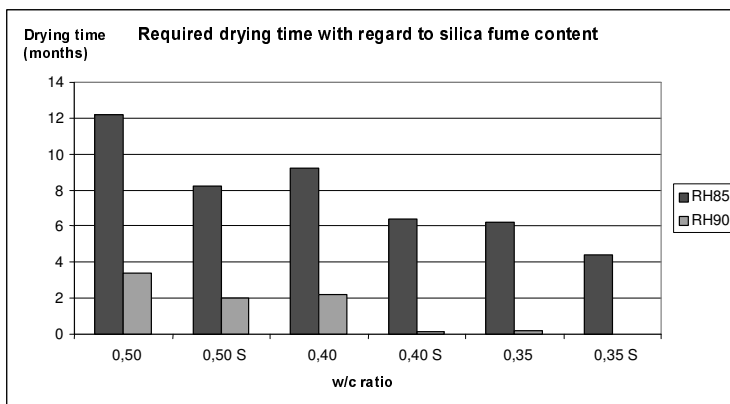

20 cm slab thickness  
S= 5 % silica fume  
Filigran-form  
w/c=water/Portland cement